

# Version E-Box INTELLIPOOL

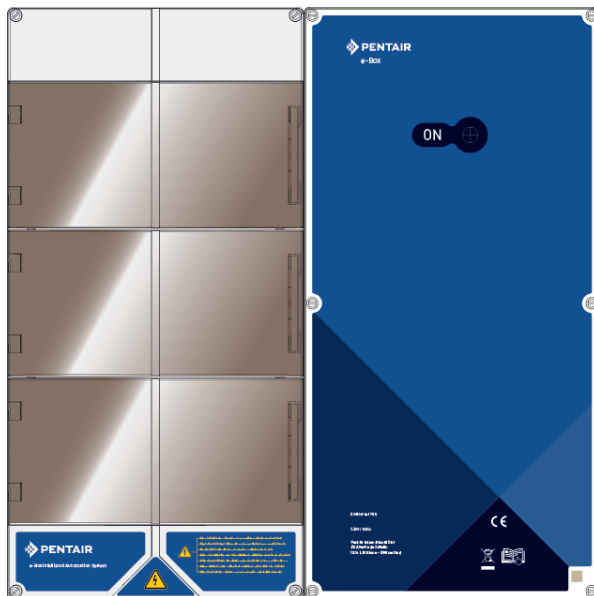

## IMPORTANT SAFETY INSTRUCTIONS

Read and follow all the instructions

Keep these instructions

[WWW.PENTAIRPOOLEUROPE.COM](http://WWW.PENTAIRPOOLEUROPE.COM)

# Table of Contents

<b>1</b>	<b>General.....</b>	<b>5</b>
1.1	Scope of this document.....	5
1.2	Version Management.....	5
1.3	Manufacturer identification (ID), product.....	5
1.4	Technical assistance procedure.....	5
1.5	Copyright and Trademarks.....	6
1.6	Limitation of Liability.....	6
1.7	Declaration of conformity.....	7
1.8	Pentair Scan Application.....	8
1.9	Website and Home Automation Control Application.....	8
1.10	Website and notices additional to the installation.....	8
<b>2</b>	<b>Security.....</b>	<b>9</b>
2.1	Definition of safety pictograms.....	9
2.2	Series label locations.....	9
2.3	Risks.....	10
2.3.1	Personnel.....	10
2.3.2	Hardware.....	12
<b>3</b>	<b>Description.....</b>	<b>14</b>
3.1	Technical specifications.....	14
3.2	Congestion diagram.....	15
3.3	Product Description.....	17
3.3.1	General operation.....	17
3.3.2	The E-Box.....	18
3.3.3	Control Centre.....	19
3.3.4	Probe Unit.....	20
3.3.5	Internet Relay.....	20
3.3.6	Inner Display.....	21
3.3.7	Radio Relay.....	22
3.3.8	4X Extension Unit.....	23
<b>4</b>	<b>Installation.....</b>	<b>24</b>
4.1	Warnings.....	24
4.2	Package contents.....	25
4.3	Accessories provided depending on the options chosen.....	26
4.3.1	Analysis chamber.....	26
4.3.2	Pool water treatment liquid solution injection metering pump.....	27
4.3.3	Salt electrolysis cell for chlorine production 13 or 27 g/h (optional).....	28
4.4	Tools Required for Installation.....	28

4.5	Internet Relay.....	29
4.6	Inner Display .....	30
4.7	Radio Relay.....	31
4.8	E-Box.....	33
4.8.1	Wall mounting .....	33
4.8.2	Connections.....	34
4.8.3	Connection of the " PENTAIR VSF " filter pump.....	38
4.8.4	Connection of the heat pump power supply (if installed).....	38
4.8.5	Connection of the pool automatic shutter power supply (if equipped) .....	39
4.9	Probe Unit and Control Centre .....	39
4.9.1	Wall mounting .....	39
4.9.2	Hydraulic and electrical installation.....	41
4.9.3	Installation of probes .....	42
4.9.4	Connections.....	45
4.10	4X Extension Unit .....	47
4.10.1	Menu installation 4X Extension.....	47
4.10.2	Examples of connections of IN inputs .....	48
4.10.3	AUX output connections .....	50
4.10.4	Settings done on <a href="http://www.intellipool.eu">www.intellipool.eu</a> .....	56
<b>5</b>	<b>Programming .....</b>	<b>57</b>
5.1	Programming the INTELLIPOOL Control Centre .....	57
5.1.1	Presentation.....	57
5.1.2	Setting menu .....	58
5.1.3	Lighting menu .....	61
5.1.4	Filtration menu.....	61
5.1.5	Aux1 Menu .....	62
5.1.6	History Menu .....	63
5.1.7	Installation menu .....	63
5.2	Inner Display Programming .....	65
5.2.1	Presentation.....	65
5.2.2	Air/water temperature.....	66
5.2.3	pH trend.....	68
5.2.4	Conductivity Trend .....	69
5.2.5	RedOx Trend.....	71
5.2.6	Mode in progress .....	72
5.2.7	Audible Alarm Status .....	78
5.2.8	Out-of-water probes .....	78
5.2.9	Battery level .....	79
5.2.10	Radio Signal Strength .....	79
<b>6</b>	<b>Operations .....</b>	<b>80</b>
6.1	Commissioning .....	80
6.2	Adding a Radio Relay and/or Inner Display .....	80
6.3	Re-learning the Original Inner Display.....	82
6.4	Operation of the Internet Relay .....	83

6.4.1	Home automation-pool account .....	84
<b>7</b>	<b>Maintenance .....</b>	<b>86</b>
7.1	Maintenance .....	86
7.2	Wintering of the INTELLIPOOL (T° water < +3.0°C) .....	86
7.3	pH and RedOx probes .....	86
7.4	Radio Relay and Inner Display .....	87
7.5	Cleaning the pH or RedOx probe .....	87
7.6	Alkaline battery replacement .....	89
7.6.1	Changing the Radio Relay Batteries .....	89
7.6.2	Changing Inner Display Batteries .....	90
<b>8</b>	<b>Troubleshooting .....</b>	<b>92</b>
8.1	Alert Messages .....	92
<b>9</b>	<b>Spare part.....</b>	<b>94</b>
<b>10</b>	<b>Disposal.....</b>	<b>95</b>
<b>11</b>	<b>Annexes.....</b>	<b>96</b>

# 1 General

## 1.1 Scope of this document

This document contains the information necessary for proper use of the product. It informs the user in order to guarantee the proper execution of the installation, use and maintenance procedures.

The content of this document is based on information available at the time of publication.

The original version of this document was written in French.

For reasons of safety and environmental protection, the safety instructions contained in this document must be strictly adhered to.

This document is provided for reference only and does not include all possible installation situations. The person responsible for installing this equipment must have:

- Followed adequate training for the installation of swimming pools.
- A good knowledge of the pool equipment as well as their settings.

This document is available in other languages on the page [www.pentairpooleurope.com](http://www.pentairpooleurope.com)

## 1.2 Version Management

Review	Date	Authors	Description
A	11.05.2023	STF/YML	First edition.

## 1.3 Manufacturer identification (ID), product

Manufacturer: Pentair International LLC  
Avenue de Sevelin 20  
1004 Lausanne  
Suisse

Product: E-Box INTELLIPOOL

## 1.4 Technical assistance procedure

Procedure to follow for any request for technical assistance:

1. Collect the information that is necessary for a technical assistance request.
  - ⇒ Product identification [see Series label locations [→Page 9]].
  - ⇒ Description of the problem that the device has.
2. Refer to the chapter Troubleshooting [→Page 92]. If the problem persists, contact your supplier.

## 1.5 Copyright and Trademarks

All trademarks and logos Pentair are the property of Pentair. The brands, trademarks and logos of third parties are the property of their respective owners.

© 2023 Pentair. All rights reserved.

## 1.6 Limitation of Liability

As part of the quality system Pentair, the products benefit, under certain conditions, from a manufacturer's guarantee, which the direct customers of Pentair can access. Users must contact the reseller of this product for the applicable conditions and in the event of a possible warranty claim.

With the exception of probes and consumables, the warranty is 2 years.

Any warranty provided by Pentair regarding the product will be annulled in the following cases:

- Installation carried out by a person not specialised in the installation of swimming pool;
- Non-compliant installation, programming, use, operation and/or maintenance causing any damage to the product;
- Non-compliant or unauthorised work on components;
- Incorrect, inappropriate or incorrect connection/assembly of systems or products in connection with this product and vice versa;
- Use of a lubricant, grease or chemical of any type not compatible with the product and not listed as compatible with the product by the manufacturer;
- Failure due to incorrect configuration and/or measurements.

Pentair declines all liability for equipment installed by the user contrary to the instructions given for the products Pentair, as well as for any production procedure or process, installed and connected around the installation, indeed related to this. All direct or indirect malfunction or failure and any damage caused by such equipment or process are also excluded from the guarantee. Pentair does not accept any liability for any loss or any prejudice as regards profits, revenue, usage, production or contracts, or for any indirect, special or consecutive loss or damage, whatever the nature may be.

## 1.7 Declaration of conformity

### Guidelines – Harmonised standards

Pentair International LLC - Avenue de Sevelin 20 - 1004 Lausanne - Suisse

We declare that the product meets the guidelines and take responsibility for it:

#### RED

- 2014/53/EU.

#### SAFETY

- EN 62368-1:2014;
- EN 62311: 2008.

#### EMC

- EN 301 489-1 V2.2.0;
- EN 301 489-3 V2.1.1;
- EN 55024: 2010 / A1: 2015.

#### RADIO

- EN 300 220-2 V3.1.1.

#### INTELLIPOOL (+ PARTS)

- INTP-1010C.

#### PART NUMBERS

- SB-SE-PRO-004C;
- INTP-5163;
- INTP-1030B;
- INTP-5160;
- INTP-5150;
- INTP-5164.



#### Other normative documents

- 2002/95/EC (RoHS)
- 2002/96/EC (WEEE)



## 1.8 Pentair Scan Application

The mobile application Pentair Scan is an ideal tool for the daily work of the maintenance technician. The simple reading of the identification label present on the product, with a smart phone, gives instant access to all its information.

1. Download the Pentair Scan application from  or  on a smart phone.
2. Open the Pentair Scan application.
3. Scan the label affixed to the product.
4. Navigate through the information.

## 1.9 Website and Home Automation Control Application



The Intellipool is a necessary application for controlling your installation remotely. It is not limiting and can be installed on several media (phone and tablet) with the same identifiers.

The use of an internal connection via a computer is necessary to configure the E-Box.

It is free, no subscription necessary, you just have to register beforehand on the website: [www.intellipool.eu](http://www.intellipool.eu).

1. Visit the [www.intellipool.eu](http://www.intellipool.eu).
2. Obtain the information present on the side of the INTELLIPOOL (Pool ID and ID Key).
3. Register by clicking on "create an account".

Once registered on the website:

1. Download the Intellipool from  or  on a smart phone or a table (not supplied).
2. Open the Intellipool.
3. Enter your Login information and your password (previously registered on the website).
4. Navigate within the application and manage your installation.

## 1.10 Website and notices additional to the installation

We advise you to read and download the instructions for the various equipment available on the website: [www.pentairpooleurope.com](http://www.pentairpooleurope.com)

Access is free, no subscription required.

As a professional a section is dedicated to you and you just have to register on this same site and make a request for access.

Download the documentation relating to the various products (IntelliPool boxes, electrolyser, IntelliFlo filtration pump, etc.).



## 2 Security

### 2.1 Definition of safety pictograms

 **DANGER**



This combination of symbol and keyword indicates an imminently hazardous situation that will result in serious or fatal injury if not avoided.

 **WARNING**



This combination of symbol and keyword indicates a potentially hazardous situation that can result in serious or fatal injury if not avoided.

 **CAUTION**



This combination of symbol and keyword indicates a potentially hazardous situation that can result in minimal or minor injury if not avoided.

**Caution - material**



This combination of symbol and keyword indicates a potentially hazardous situation that can entail material damage if not avoided.

**Prohibition**



Mandatory advice to follow.

**Mandatory**



Applicable guideline, measure.

**Info**



Informative comment.

### 2.2 Series label locations

**Mandatory**



**Make sure that the serial and safety labels on the device are perfectly legible and clean!**  
If necessary, replace them with new labels to be placed in the same place.

## 2.3 Risks

All safety and protection instructions contained in this document must be followed in order to avoid injury, property damage or environmental, irremediable or temporary pollution.

Likewise, all other regulations and measures for accident prevention and environmental protection, as well as any recognised technical regulations relating to safe and appropriate working methods applicable in the country and at the place of use of the device must be complied with.

Any violation of safety and protection rules or any existing legal and technical regulations may result in irreparable or temporary injury, property damage or environmental pollution.

### 2.3.1 Personnel

#### DANGER



#### **Risk of electric shock or electrocution:**

Before working on the E-Box INTELLIPOOL:

- Always turn off power to the INTELLIPOOL controller to the switch before the maintenance. Failure to do so could result in death or serious injury to the technician, pool users or others due to electric shock.
- Please disconnect the connections before working on the INTELLIPOOL; the AC power can be supplied to the relay terminals close to other sources.

#### DANGER



#### **Chemical burn hazard!**

Be sure to shut off all pumps at the main circuit breakers on the home switchboard before drilling in any line. Properly fix all electrical, water and chemical lines. Consolidate feed pumps and chemical tanks in a safe and secure area.

#### WARNING



#### **Safety tips on the standard solution!**

The standard solution pH 4 is acidic. It must be kept away from children and securely close it to the right of the bottle. Store in a dry, ventilated place. Do not expose to frost.

**WARNING**

**Water temperatures above 37.7°C are a health hazard!**

Prolonged immersion in hot water can cause hyperthermia. Taking alcohol, drugs or medication is a factor aggravating the risk of hyperthermia in hot water baths and spas.

Hyperthermia occurs when the internal temperature of the body exceeds by several degrees the normal temperature of 37°C. Hyperthermia can produce the following effects:

- Inability to perceive imminent danger.
- Insensitivity to heat.
- Inability to perceive the need to leave the pool.
- Physical inability to leave the pool.
- Foetal injury in pregnant women.
- Syncope resulting in danger of drowning.

**CAUTION**

**Risk of injury due to improper handling!**

Only qualified personnel and duly trained professionals are authorised to carry out the required work, according to their training, experience, instructions received and their knowledge of the safety rules as well as the operations to be carried out.

**Prohibition**

**Do not allow children to operate this equipment!**

Risk of injury.

**Prohibition**

**Do not use this product to control an automatic pool shutter!**

Swimmers may find themselves trapped under the shutter.

**Mandatory**

**Strictly follow the safety and handling procedures of the acid manufacturers!**

Including protective measures for hands, body and eyes during transfer and handling of acid. Also observe the safety precautions prescribed for handling muriatic acid intended to control the pH of the water. Muriatic acid can cause serious bodily harm and damage to swimming pool equipment.

**Mandatory**

**Check the pH and disinfectant levels of the water before using the pool and make sure the water filtration device is not clogged!**

Use an independent pH and chlorine test kit very periodically to ensure that the pH and chlorine level meet safety requirements. PH, RedOx, or conductivity sensors that are degraded, discharged, or clogged by oils, lotions, or other contaminants are likely to return incorrect results in the system and induce improper chemical treatment of the water, thereby creating a hazard to people and equipment.

**Mandatory**

**This installation and operation guide contains important information about the installation, operation and safety of this product!**

This guide should be provided to the owner and / or operator of this product.

**2.3.2 Hardware**** DANGER**

**Risk of electric shock or electrocution!**

Connect the E-Box INTELLIPOOL to a differential circuit breaker.

Reminder: the power cables of the pool lights must not be routed to the pool by means of sheaths containing other electrical cables.

Refer to local standards for details.

**Mandatory**

**Comply with regulations!**

Most countries regulate the construction, installation and operation of public swimming pools, spas and residential pools. It is important to comply with these rules, many of which directly regulate the installation and use of this product. Check your building and local health codes for more information.

**Mandatory**

**When mixing acid and water, always add the acid to the water!**

Never add water to the acid. When adding a chemical to the pool, be sure to follow the manufacturer's instructions and be equipped with appropriate protective equipment.

**Mandatory**

**Observe special precautions when installing, servicing and operating acid supply pump systems!**

The acid is dangerous to handle and requires the application of appropriate special measures with regard to its containers, transport, filling, storage, distribution and handling procedures.

**Mandatory**

**Check the daily display INTELLIPOOL!**

Make sure that no alarm message is active.

**Mandatory**

**For all components other than remote controls, observe a distance of at least 1.5 m from the inner wall of the pool or spa!**

**Mandatory**

**Sufficient equipotential bonding (min. 4.5 mm<sup>2</sup>), according to local regulations, is mandatory on all metal components of the pool, including the pool pump!**

This is necessary for electrical safety, as well as to reduce the risk of corrosion.

**Prohibition**

**Do not mix sodium hypochlorite and muriatic acid (hydrochloric acid)!**

**Do not mix out of water, chlorinated product and pH fix!**

**Info**

**Devices intended for any other use than use by a one person family, may require additional safety equipment to comply with local regulations!**

**Info**

**This product is exclusively intended for swimming pool applications.**

## 3 Description

### 3.1 Technical specifications

#### E-Box

Protection rating	IP44
System pre-wiring	INTP-1010C
Operating voltage	230V
Input power supply frequency	50 Hz
Power	14 kW max
Number of inputs	7x
Number of outputs	8x (230V/16A max) 4x (12V/16A max) 1x (24 V/3 A max) 7x dry contacts 8A max
4X Extension Unit Module	Included

#### Control Centre, Probe Unit, Radio Relay and Inner Display

Product specifications	Model INTP-1010C
Operating temperature	0° to 40°C
Operating humidity	40% at 75°C
Maximum operating altitude	2000 m
Weight (excluding probes)	3.5 kg
Consumption Probe Unit	2.4 W
Consumption Control Centre	16 W
Radio Relay (outer use)	IP 65
Control Centre + Probe Unit (inner use)	IP 64
Inner Display (inner use)	IP 20
Internet Relay (inner use)	IP 30
Internet Relay mains power supply specifications 230 V/DC Jack 5.5/2.1 mm (external negative)	VEL05US060-EU-JA
Input	100-240 V 50/60 Hz 0.18 A
Output	6.0 V 0.83 A max

#### Environmental conditions

- For inner use only;
- Temperature from 5°C. to 40°C.;

- Maximum relative humidity of 80% for temperatures up to 31°C decreasing in a linear manner to 50% relative humidity at 40°C;
- Mains power supply voltage variations of  $\pm 10\%$  of the nominal voltage.

## 3.2 Congestion diagram

### E-Box

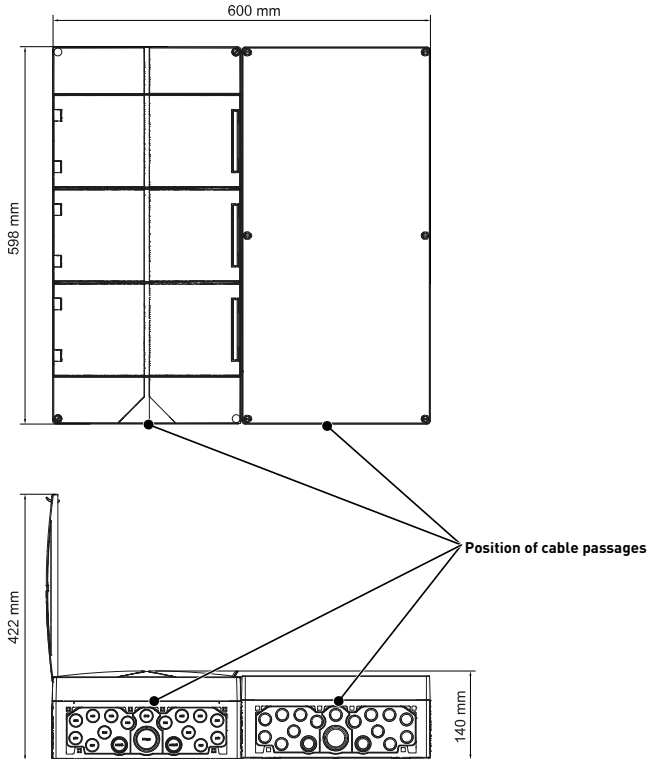

**Control Centre and Probe Unit (both cases have the same dimensions)**

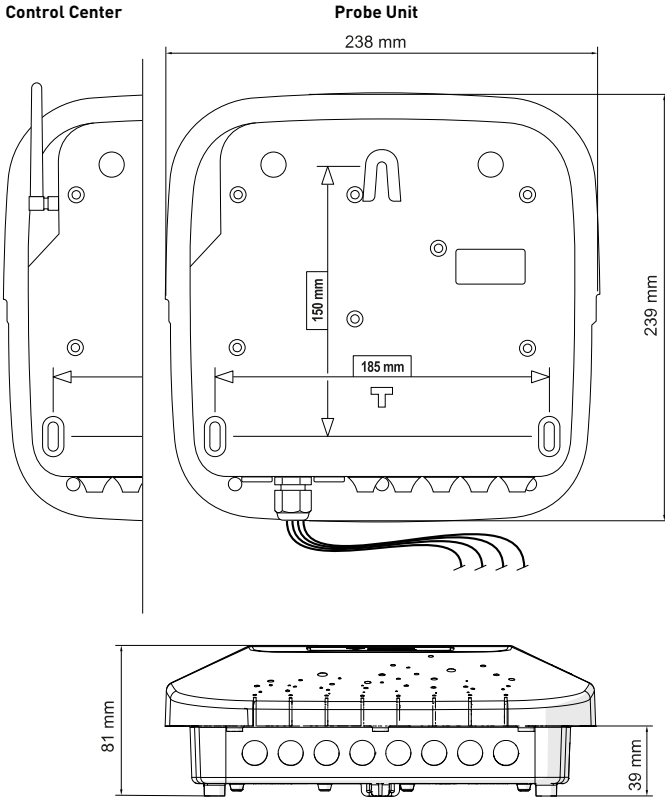



### 3.3 Product Description

#### 3.3.1 General operation

The diagram below describes an example of a typical installation of a fully automated and remotely controlled swimming pool. Refer to the relevant item for more information about it.

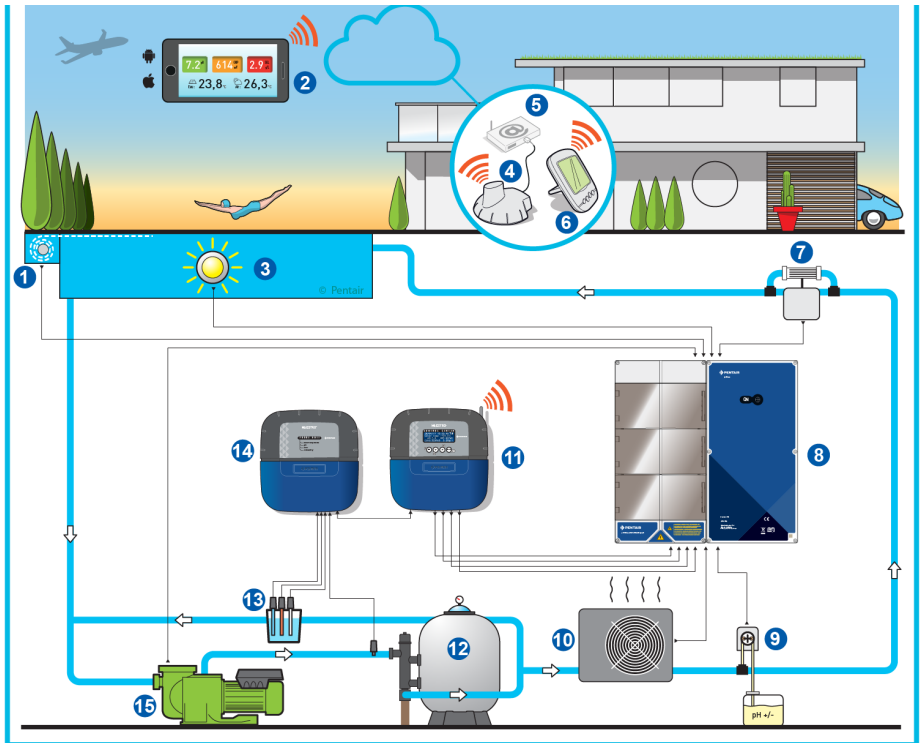

- |   |                               |    |                                    |
|---|-------------------------------|----|------------------------------------|
| 1 | Roller shutter                | 9  | Peristaltic pump                   |
| 2 | Home automation swimming pool | 10 | Heating                            |
| 3 | Lighting                      | 11 | Control Centre                     |
| 4 | Internet Relay                | 12 | Filter                             |
| 5 | Internet box                  | 13 | Probes (pH + RedOx + Conductivity) |
| 6 | Inner Display                 | 14 | Control Unit                       |
| 7 | Electrolyser                  | 15 | VS Pump                            |
| 8 | E-Box                         |    |                                    |

### 3.3.2 The E-Box

The E-Box is a turnkey system for quickly and simply making all the connections to the various pieces of equipment in the installation.

The connections between the boxes provided (E-Box and INTELLIPOOL are carried out through cables to rapid connectors and thus allow operation by means of control and information remotely (this occurs with the connection of the installation to the internet through box internet of the user).

Your E-Box version INTELLIPOOL contains a 4X Extension Unit module (this allows the control of complementary and additional equipment).

No intervention is necessary inside your E-Box except the connection to the terminal blocks, in order to carry out the connections of the various devices that constitute the installation.

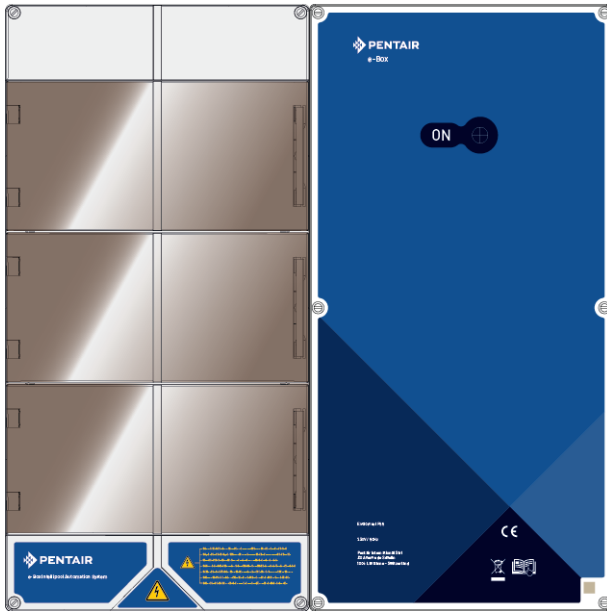

### 3.3.3 Control Centre

The Control Centre automatically controls and calculates the operating time of the equipment connected to the system, it is the brain of the installation.

It receives the orders transmitted by the remote control device or by the internet and communicates with the device concerned.

In addition, the activity can be consulted by the user and is stored in memory. One can ask it questions through the website.

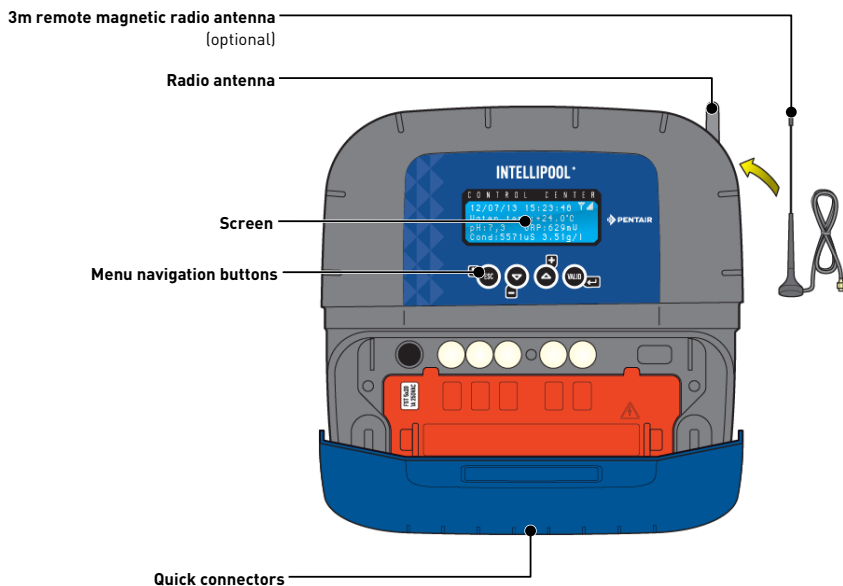

### 3.3.4 Probe Unit

The device is equipped with five probes that allow it to measure the properties and values of the water.

The information collected is then transmitted to the Control Centre to refine the adjustment of the water regulation.

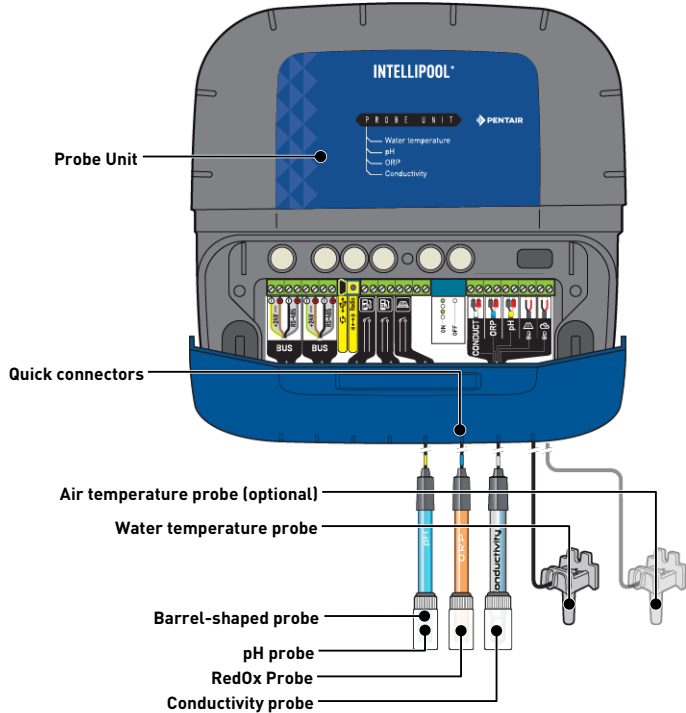

### 3.3.5 Internet Relay

The Internet Relay allows you to stay in touch with your installation. You have access to your data in real time and you can also access it through settings and controls from a computer, a tablet or a smart phone connected to the internet.

You must be connected to the internet through your box in order to be able to control and ask your installation questions.

To be functional, the Internet Relay must be connected to your internet box. The connection to the [www.intellipool.eu](http://www.intellipool.eu) is automatic.

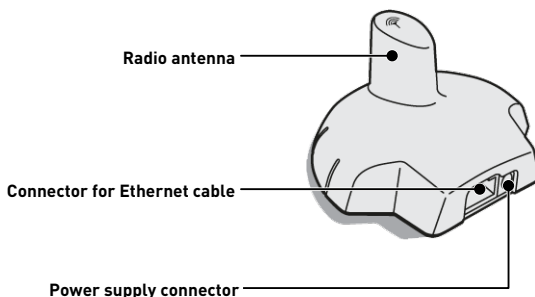

This relay, once connected to your internet box (see Internet Relay [->Page 29]), created a radio network allowing it to send and receive information from your installation.

### 3.3.6 Inner Display

The inner display is a device giving access to all the parameters of water quality and comfort (temperatures and UV). The data is updated every 15 minutes.

It is intended for inner use only.

Pre-programmed alerts make it possible to check the chemical balance of the water without analysis at the edge of the basin.

For more information, refer to the chapter Inner Display Programming [->Page 65].

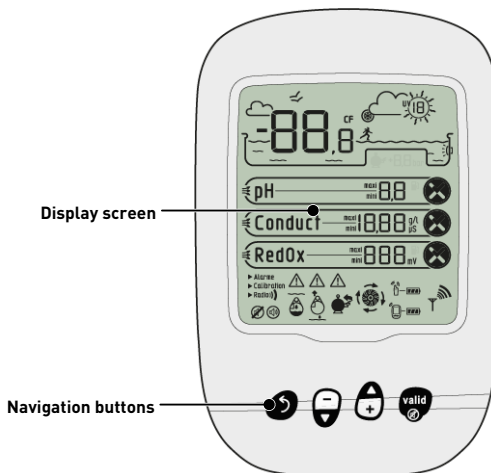

### 3.3.7 Radio Relay

The Radio Relay is used to relay radio waves between the technical room and the internet box through the Internet Relay.

It must be placed outside, for example in the garden halfway between the technical room and the house. Thus it will also be able to measure the UV index and the outside temperature.

In case of great distance or a garden with a lot of relief, it is possible to add one or two additional Radio Relays.

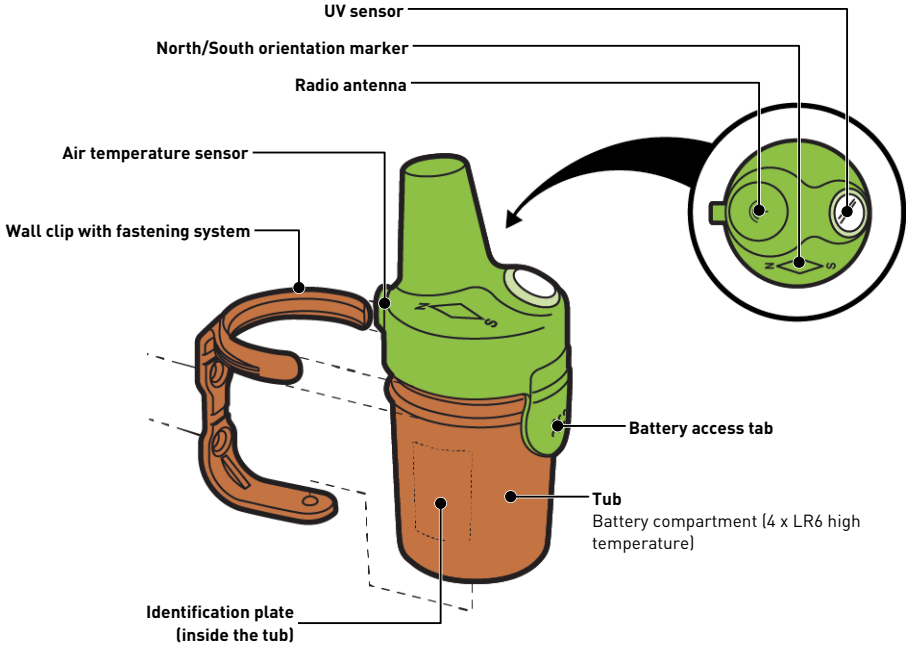

### 3.3.8 4X Extension Unit

The 4X Extension module is an input and output extension module installed in your E-Box. It will allow you to connect more equipment to your system. The module consists of 4 IN inputs, 2 AL alarm inputs and 4 AUX outputs.

To be functional, the 4X Extension module must be configured through the website only.

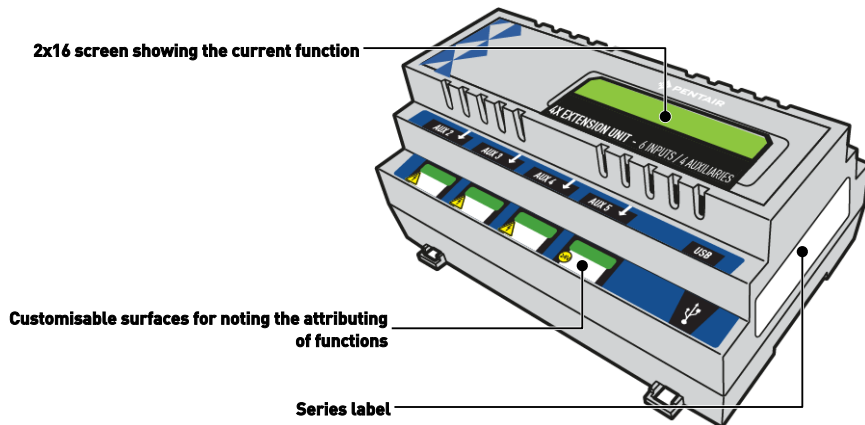

## 4 Installation

### 4.1 Warnings

#### CAUTION



#### **Risk of injury due to electric shock or pressurised elements!**

It is strictly forbidden for any unqualified personnel to access the internal components of the system in order to carry out any technical work whatsoever.

- Check that the power supply is switched off. Close the water inlet and relieve the system of pressure before opening the hood to access the internal components.

#### Mandatory



**The equipment is permanently connected.**

#### Mandatory



**The equipment must be installed by a qualified technician according to the local regulations in force.**

#### Info



**Each output has a normally open dry contact for a maximum voltage of 230 V.**

The manufacturer is not responsible for any personal injury or material damage resulting from improper use of the device or any use that is not in accordance with the following instructions.

In case of any doubt in this manual regarding installation, operation or maintenance, please contact the technical support of the company that installed the device.

The installation of the device must be carried out by a qualified technician in compliance with the standards and regulations in force, using tools compatible with the device for safe use. This same technician must also ensure the maintenance of the device.

In case of failure or malfunction, before performing any repair work on the device, ensure that the E-box is disconnected from the power supply:

1. Be careful when unpacking and during subsequent handling, as the weight is likely to cause property and personal injury in the event of an accidental impact.
2. Before any electrical connection, earth the installation.
3. Ensure that the environment in which the appliances are installed does not reach temperatures that may cause the water to freeze, as the valve may be damaged.



## 4.2 Package contents

- 1 E-Box
- 4 Cables for the connections of the INTELLIPOOL in the E-Box
- 1 Intelliflo VSF pump control cable
- Cable glands set for installation of cables in box E-Box
- 1 Control Centre INTELLIPOOL
- 1 Probe Unit INTELLIPOOL
- 4 Probes (pH, RedOx, conductivity and temperature)
- 2 Chemical solutions for pH probe calibration (pH4 and pH7 solutions)
- 1 Analysis chamber with associated pipes and fasteners
- 1 Inner Display
- 1 Radio Relay
- 1 pack of 8 AA size batteries
- 1 Internet Relay
- 1 power cable for Internet Relay with integrated transformer
- 1 RJ45 cable for Internet Relay
- 1 Peristaltic pump 1.5 l/h for injection of liquid pH correction solution

### **Depending on the options chosen:**

- 1 Peristaltic pump 1.5 U/h for the injection of liquid chlorine or liquid peroxide, special swimming pool
- 1 Intellichlor salt electrolysis cell (13 or 27 g/h of production)

## 4.3 Accessories provided depending on the options chosen

### 4.3.1 Analysis chamber



Supplied with the installation kit, it must be installed as close as possible to the Probe Unit box, and receives the measurement probes provided: RedOx, pH and conductivity.

This chamber contains a flow rate detector incorporated therein.

It is necessary during the installation of the analysis chamber, to comply with the direction in which the water in it is passing (see Installation of probes [[->Page 42](#)]).

Analysis chamber kit contents:

- 1 bowl for 3 probes with built-in flow sensor;
- 2 support clamps with a diameter of 50 mm;
- 3 m of 6/12<sup>th</sup> transparent tube;
- 2 DN.15 ¼ turn PVC valves with fittings for the hydraulic tube.

### 4.3.2 Pool water treatment liquid solution injection metering pump

The solution injection metering pump is supplied with the installation kit, it must be installed separately from the electrical box, integral with the wall of the technical room, in accordance with its instructions.

When installing the peristaltic dosing pump, it is necessary to respect the direction of pumping of the product therein and to respect a maximum product suction height of 1.5 m from the ground.

This equipment is designed to inject a water treatment product for swimming pools, in liquid form.

Metering Pump Kit Contents:

- 1 peristaltic pH pump, flow rate 1.5 l/h at 1.5 bar;
- required wall-mounting kit;
- 2 x 2 m injection tube;
- 1 injector with 1/2" adapter;
- 1 product suction strainer.



The connection of this equipment is carried out at the level of the box E-Box, as explained in detail Connections [[→Page 34](#)].

### 4.3.3 Salt electrolysis cell for chlorine production 13 or 27 g/h (optional)



This equipment is intended for the production of chlorine from swimming pool water.

The salt electrolysis cell is provided as an option with the installation kit, it must be installed bypass or online (max accepted flow rate of 18 m<sup>3</sup>/h).

It works with 3.5 g of salt per liter of water.

It must be supplied with low voltage by the box E-Box.

The cell has a built-in control panel.

Refer to the manual for this equipment for installation, adjustments and maintenance.

## 4.4 Tools Required for Installation

You will need the following tools in order to perform the installation in the best possible conditions:

- A flat screwdriver set;
- A drill with adapted bits;
- A tape measure;
- One level;
- A compass.

## 4.5 Internet Relay

### Info



**Install and connect the Internet Relay first.**

The pairing of the various devices will thus be automatic.

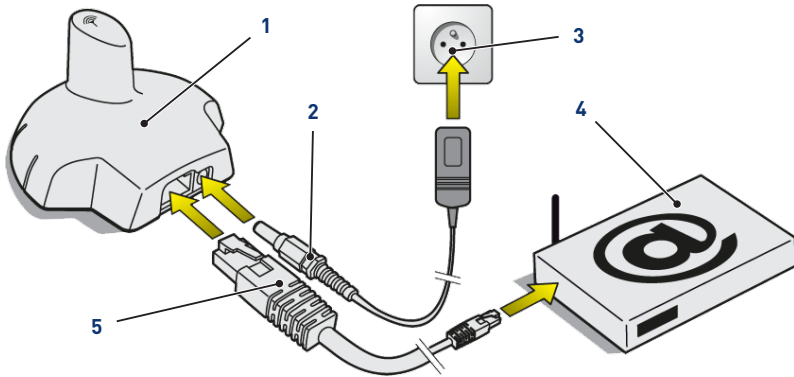

1. Connect the provided Ethernet cable (5) to the Internet Relay (1) and your internet modem (4).

### Info



**In the event of a connection problem with the technical room, the supplied Ethernet cable can be replaced by an equivalent cable with a maximum length of 100 meters.**

2. Connect the power cord (2) to the Internet Relay (1) and to an electrical socket (3).
  - ⇒ The Internet Relay is then configured automatically. The relay dome is then backlit in fixed orange.

If this is not the case (the dome is not backlit or it is flashing orange), check that:

- the DHCP server of your internet modem is activated;
- port 8001 used by the Internet Relay is open.

## 4.6 Inner Display

### Caution - material



**Do not expose the appliance to sun (UV) or rain.**

Risk of irreversible damage to the interior display.

The display is intended for inner use.

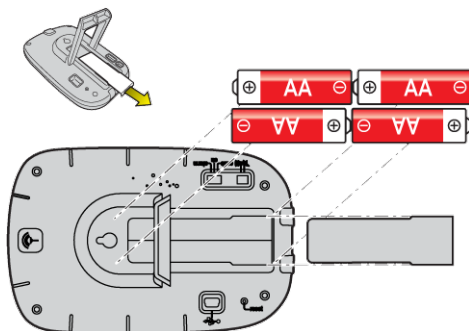

1. Install 4 AA batteries indoors.

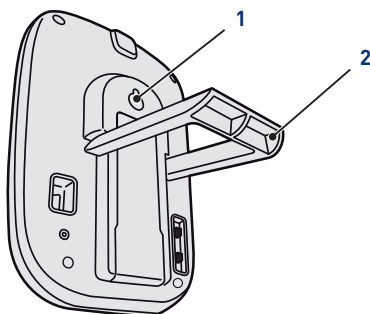

### On a table

1. Unfold the tripod [2].
2. Place the display on a stable table.

### On a wall

1. Use the wall hanger [1] to hang the display on a wall.

## 4.7 Radio Relay

### Start-up

**Info**



**Switching on a Radio Relay or Inner Display triggers the recognition/machine learning of a radio code.**

1. Remove the the tub by pulling on the tab.

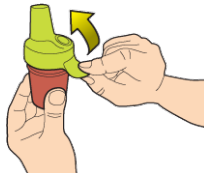

2. Place the jumper in the OFF position to avoid disturbing the outdoor temperature and UV index values of Radio Relay K no. 1, Radio Relay [→Page 22].

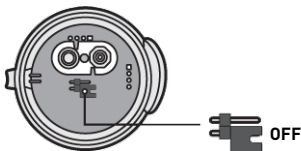

3. Remove the insulating film from the batteries.

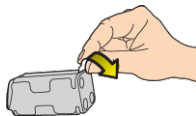

4. Reconnect the battery pack.

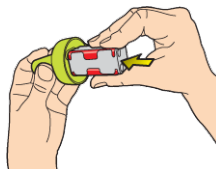

5. Raise the jar.

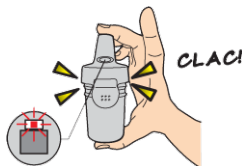

⇒ The red LED is flashing.

## Positioning

### Info



**The Radio Relay should be placed high up (on a wall or pole for example), away from any metal object (iron fence, zinc gutter).**

1. Use the compass to orient the Radio Relay to the south thanks to the reference provided for this purpose.

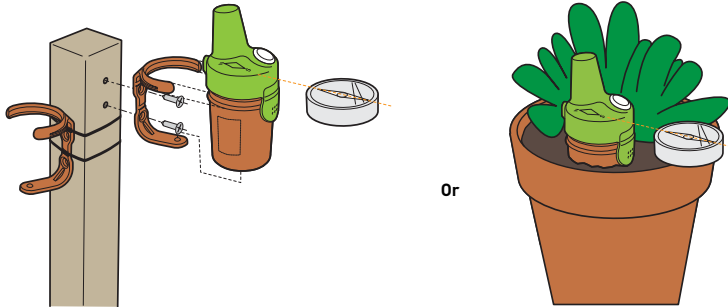

2. Place the Radio Relay according to one of these configurations:

- ⇒ directly into the earth (planter).
- ⇒ between two pots on a window edge.
- ⇒ screwed on a stake or on a wall using its support.
- ⇒ tightened on a stake using its support and tightening flanges.

### Info



**Always replace the 4 batteries at the same time and with professional batteries.**

**If the Radio Relay falls to the ground, check that it has not suffered any damage and reinstall it, taking care to fit the two parts together.**

### Info



**The display of the data can be refreshed by positioning the switch on "CALIB" and then returning to "ON" (on the back of the display). This manipulation makes it possible to visualize, after 10 seconds, the strength of the radio signal at each Radio Relay positioning test.**

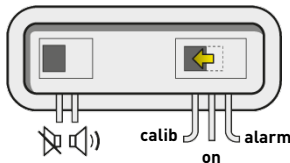

### Info



**In case of very great distance between the pool and the house, it is possible to add one or two Radio Relays (option).**

See Adding a Radio Relay and/or Inner Display [[→Page 80](#)].



## 4.8 E-Box

### 4.8.1 Wall mounting

#### Caution - material



**The device must not be installed outdoors, preferring instead a technical room inaccessible to children.**

- Ensure that the bracket on which the appliance is installed can support a load of 10 kg.
- Use dowels suitable for the bracket on which the enclosure is to be installed.

✓ The casing should rest on a workbench.

1. Unscrew the twelve screws (2).
2. Remove the two covers (3).
3. Use a drill to make four holes (1).

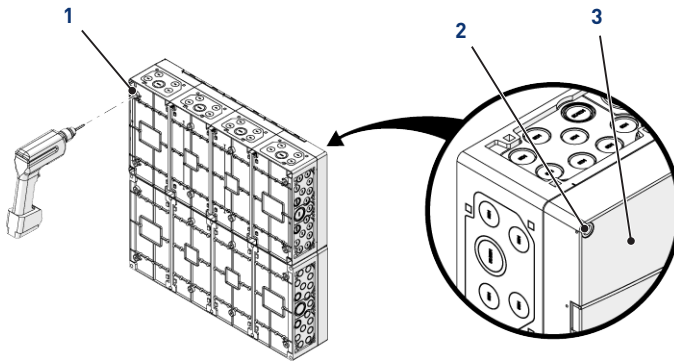

#### Tip



**It is advisable to drill the holes (1) of the four corners of the E-Box (6).**

**Otherwise, take into account the centre of gravity of the E-Box in order to determine the position of the holes.**

4. Mark the four holes (4) to be drilled in the wall.
5. Drill through the wall at the previously marked locations.
6. Insert one dowel into each hole.
7. Secure the E-Box (6) with four screws (5).

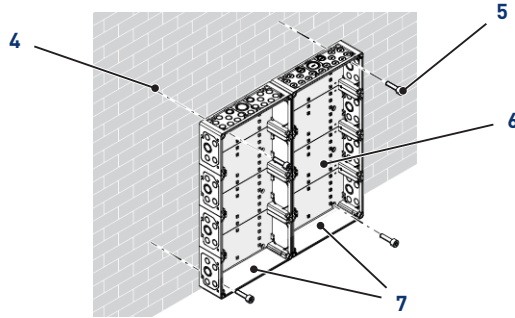

**Info**



**The quick-connect cables are connected to the bottom of the E-Box [7].**

Install the cable ducts provided according to the diameter and number of cables used.

The cable ducts prevent moisture or acid vapour from entering the device. Never leave an empty hole unused without protection. See the chapter Connections [→Page 34].

**4.8.2 Connections**

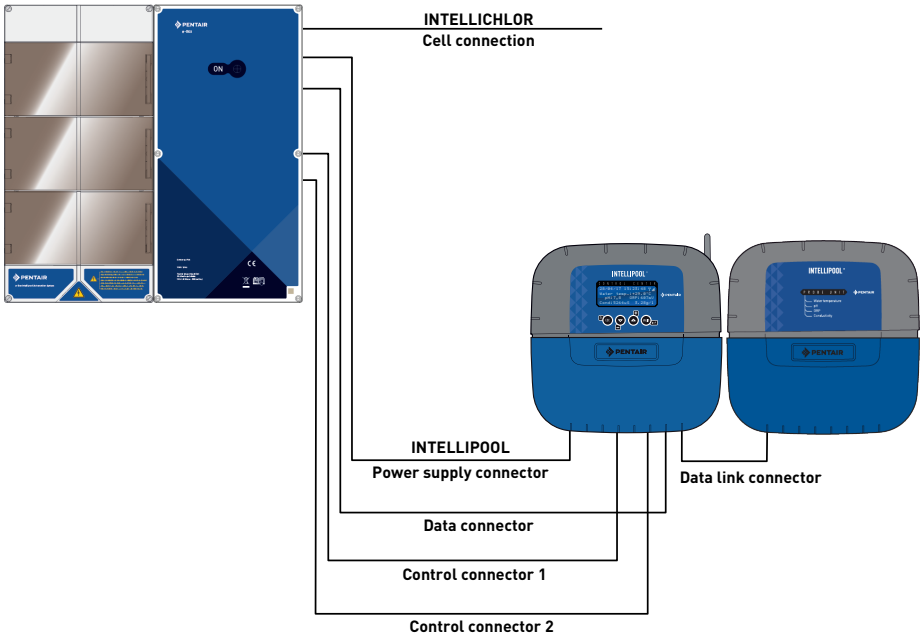

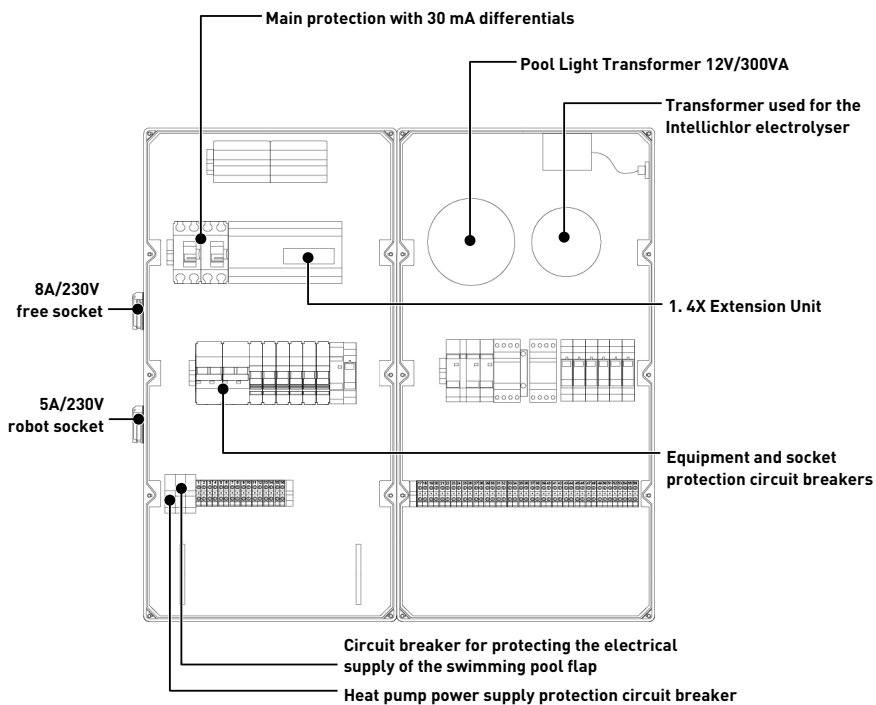
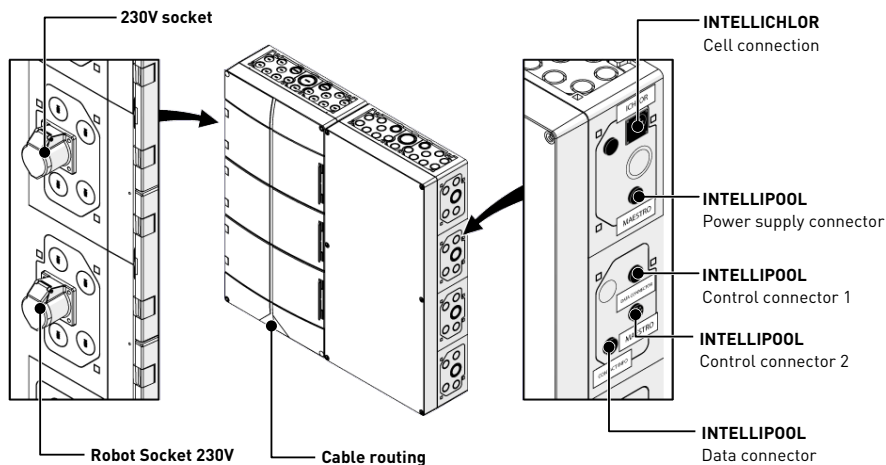

**1** 4X Extension Unit [->Page 47]





- 43-44** Connection of the temperature sensor when solar heating is used
- 45-46** +/- output for the connection of a filling solenoid valve (24 V)
- 47-48** Output +/- bus data supply (24 V)
- 49-50** DATA output +/- BUS mode for the connection of Pentair equipment (IntelliFlo VSF filter pump, Invertemp heat pump)
- 51 to 58** Connection of swimming pool projectors (12 V/50 W unit)

**Prohibition**



**Never supply voltage (Neutral + Phase) to IN, AL inputs and AUX outputs!**

In order to operate the outputs correctly, it is necessary to configure them on the website. These settings may be partly carried out on the interface of the INTELLIPOOL, through the related menus.

**4.8.3 Connection of the " PENTAIR VSF " filter pump**

The connection of the supply phase, the neutral and the earth must be made through the connection terminal block according to terminals 3 and 4 (for the earth connection: proceed to the connection on the dedicated terminal block).

The connection of the control cable must be carried out on the terminal blocks 47 and 48.

**4.8.4 Connection of the heat pump power supply (if installed)**

The connection of the supply phase, the neutral and the earth must be made through the connection terminal block according to terminals 1 and 2 (for the earth connection: proceed to the connection on the dedicated terminal block).

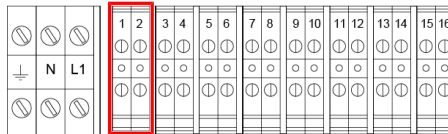

The power consumption of the heat pump shall not exceed 20 A in single phase.  
 The control of the operation of the heat pump must be connected to terminals 21-22 (refer to the instructions for the heat pump used).  
 The connection of the BUS control cable for a Pentair heat pump (Invertemp) must be made on the terminal blocks 47 and 48, do not use the terminal blocks 21-22.

**Info**



**The connection of the Bus driver cables (IntelliFlo, InverTemp) must be carried out in the Intellipoolbox on the RS-485 connectors.**

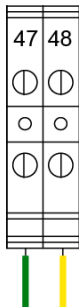

**IntelliFlo control, Pentair PAC,  
Dedicated terminal block (+) 47/(-) 48  
Inside the E-Box**

### 4.8.5 Connection of the pool automatic shutter power supply (if equipped)

The connection of the supply phase, the neutral and the earth must be made through the connection terminal block according to terminals 5 and 6 (for the earth connection: proceed to the connection on the dedicated terminal block).

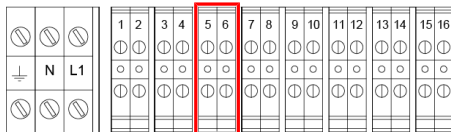

The electric consumption of the automatic shutter of the swimming pool must not exceed 16 A in single phase.

This connection allows only the electrical supply of the swimming pool shutter and not its opening or closing control.

## 4.9 Probe Unit and Control Centre

### 4.9.1 Wall mounting

#### Caution - material



**The device must not be installed outdoors, preferring instead a technical room inaccessible to children.**

- Ensure that the bracket on which the appliance is installed can support a load of 5 kg.
- Use dowels suitable for the bracket on which the enclosure is to be installed.

#### Info



**The installation procedure below is valid for Probe Unit and Control Centre devices.**

1. Mark the three holes to be drilled in the wall according to the dimension **[5]** indicated behind the device **[2]**.
2. Drill through the wall at the previously marked locations.
3. Insert one dowel into each hole.
4. Install the upper screw **[1]** and hang the device **[2]** in the place provided for this purpose.

5. Secure the appliance (2) using the two bottom screws (4).
6. Install the two covers (3) of the screws in order to ensure the tightness of the device (2).

**Info****The quick-connect cables are connected to the bottom of the appliance (2).**

Install the cable ducts and plugs with the supplied silicone grease.

Cable ducts and plugs prevent the entry of moisture or acid vapour into the appliance. Never leave an empty hole unused without protection. See the chapter Connections [→Page 45].

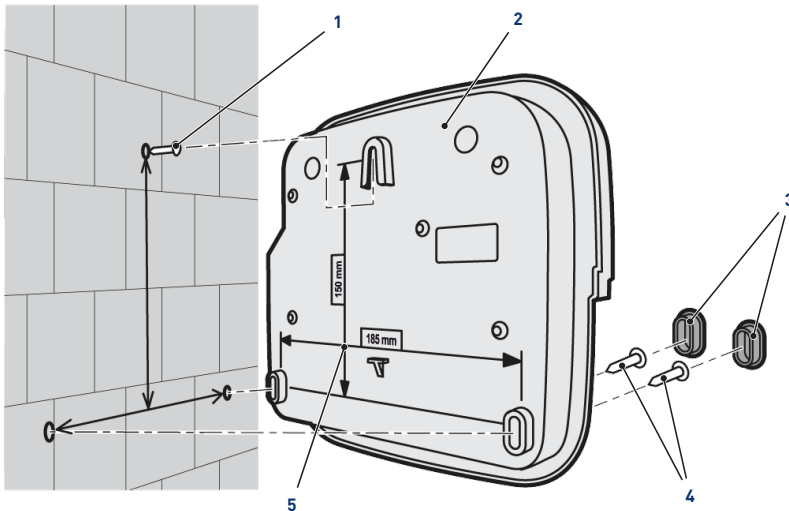



### 4.9.2 Hydraulic and electrical installation

The diagram below illustrates the electrical and hydraulic connections of the Probe Unit with the analysis chamber.

**Mandatory**



**It is imperative to isolate the bypass by closing both valves before changing a probe.**

Risk of flooding.

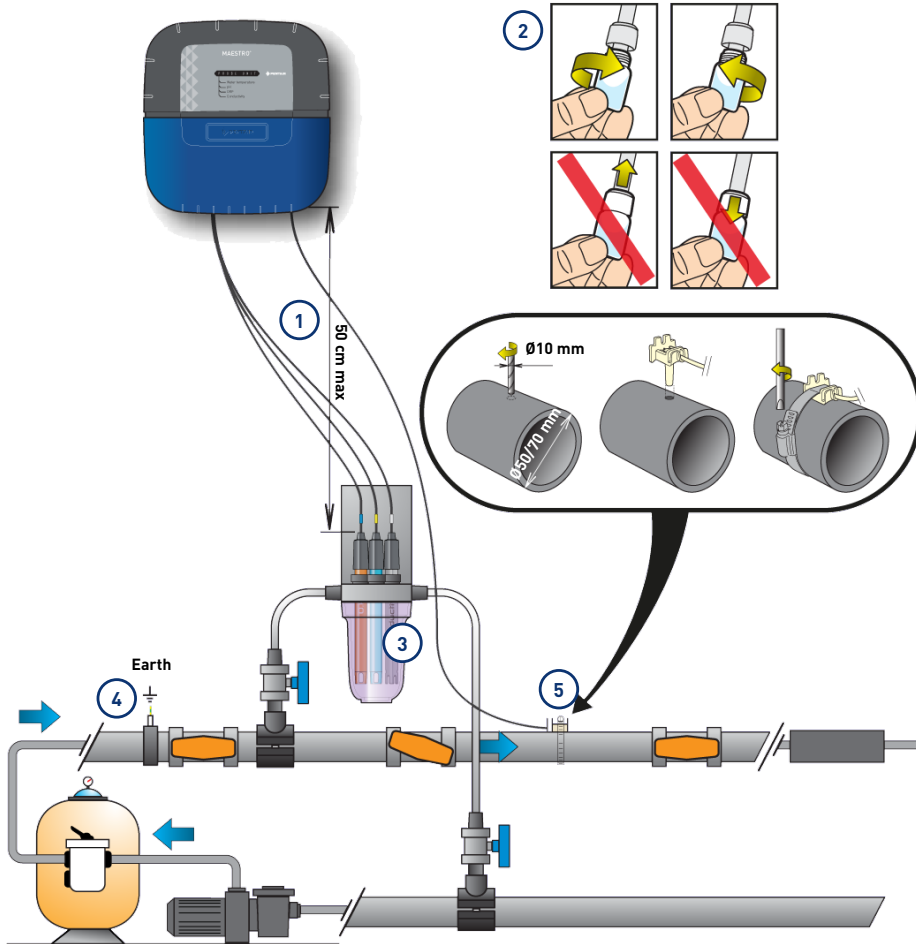

**1** The probe cables must not cross the power cable (risk of interference) or be wound on themselves.

**4** The hydraulic network must be connected to earth by means of a device validated by an electrician so as not to alter the reading accuracy of the probes.

- 2** Install the probes in the analysis chamber having previously removed the lower part (the transparent bowl) of the analysis chamber.

Installation of probes [→Page 42]

- 3** Install the analysis chamber according to the diagram and limit the flow rate in order to fill it slowly (filling in 1 minute). Then leave this adjustment of the passage of the water in the analysis chamber.

- 5** The Probe Unit comes with a probe to measure water temperature. A second probe (optional) can be installed to measure the air temperature.

For better accuracy of the water temperature sensor, install the before pump filtration.

For better accuracy of the air temperature probe, install the away from the sun.

Installation of probes [→Page 42]

### 4.9.3 Installation of probes

Installation of measurement probes in the analysis chamber (provided):

#### CAUTION



#### Filling of the probes with potassium chloride

Risk of splashing on skin, eyes and clothing

- Handle with care
- Do not ingest

#### Mandatory



The probe tubes are filled with potassium chloride.

If you want to reuse them, fill them again with potassium chloride or in the absence of running water.

Risk of damage to probes.

#### Mandatory



The conductivity probe pin should not be used for other probes.

1. Unscrew the spigots.

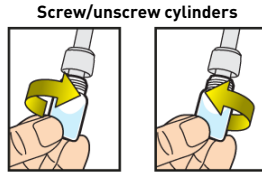

**Never push or pull the cylinders that have the cap**

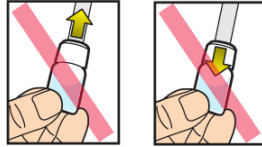

**Prohibition**



**Prohibition of pushing or pulling the cramps.**

Risk of damage to probes.

2. Install the probes in the analysis chamber provided.
3. Connect the probes to the Probe Unit, see Probe Units Connections [→Page 45].
4. Do not lengthen the probe cables.

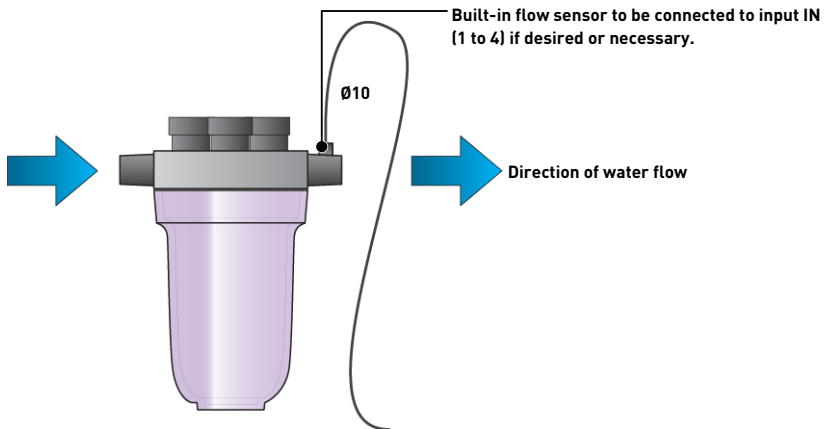

## Installing the water temperature sensor

Install the water temperature probe preferably before the pump filtration system.

1. Drill the PVC pipe (Ø50-70 mm) to make a hole with a diameter of 10 mm.
2. Remove the chips and check for the presence of the O-ring under the sensor.
3. Place the sensor in the hole then place the metal collar in the groove and tighten.
4. Connect the probe cable to the Probe Unit (see diagram Connections [→Page 45]).

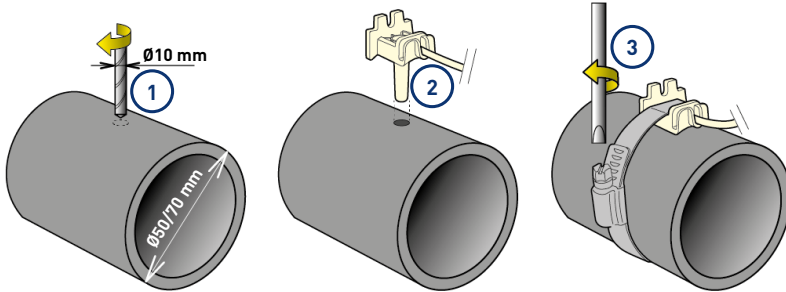

## Installing the Air Temperature Sensor (Optional)

If the air temperature sensor is connected, it automatically becomes the reference value for frost-free management. The air temperature probe is placed outside and protected from the sun's rays so as not to distort the measurement. It spreads easily thanks to its 6 m long cable.

### Info



If an air temperature probe is connected, then the air temperature information from the radio relay will no longer be retained.

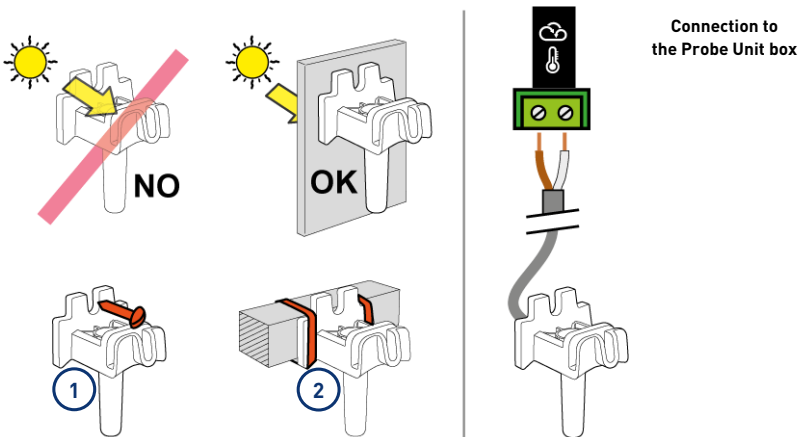

- 1 Fastening to a wall by screwing
- 2 Rilsan collar attachment to a horizontal bar of a grid

### 4.9.4 Connections

#### 4.9.4.1 Probe Units Connections

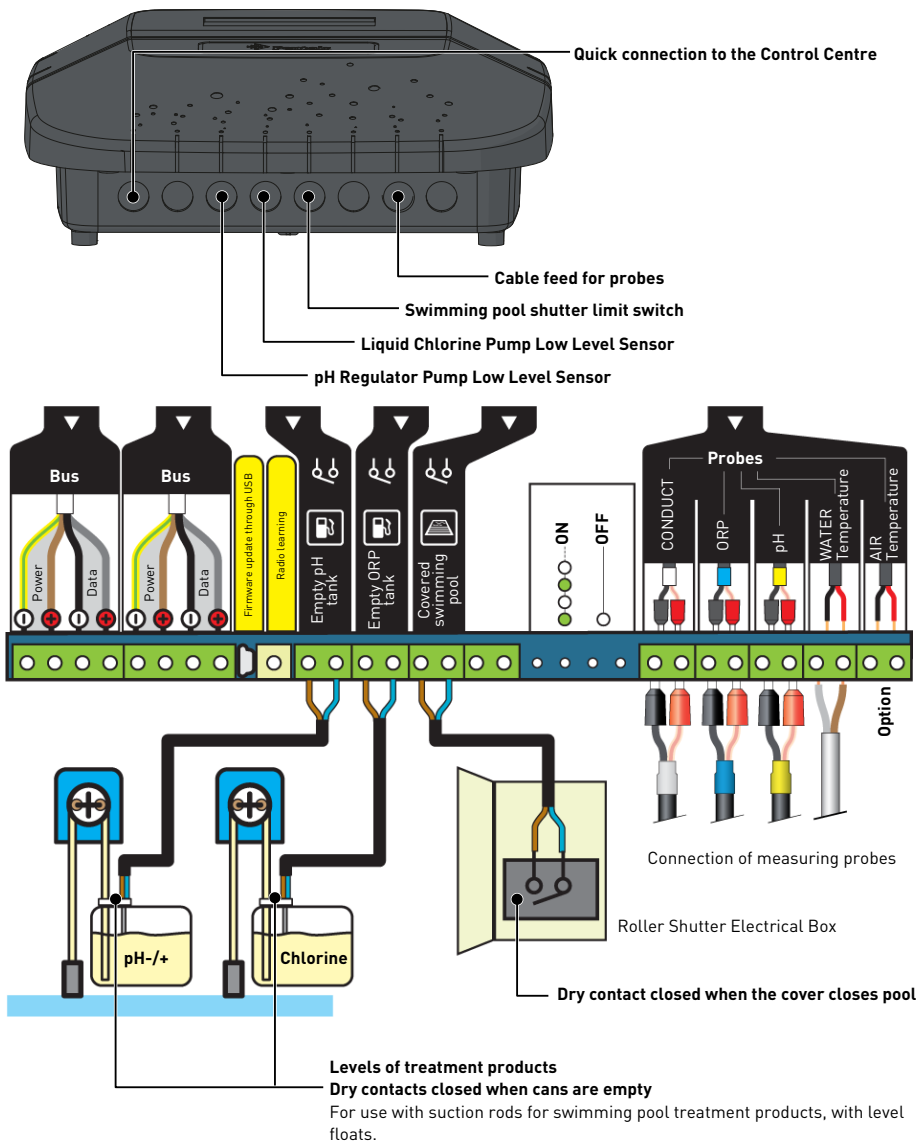

#### 4.9.4.2 Control Centre connections

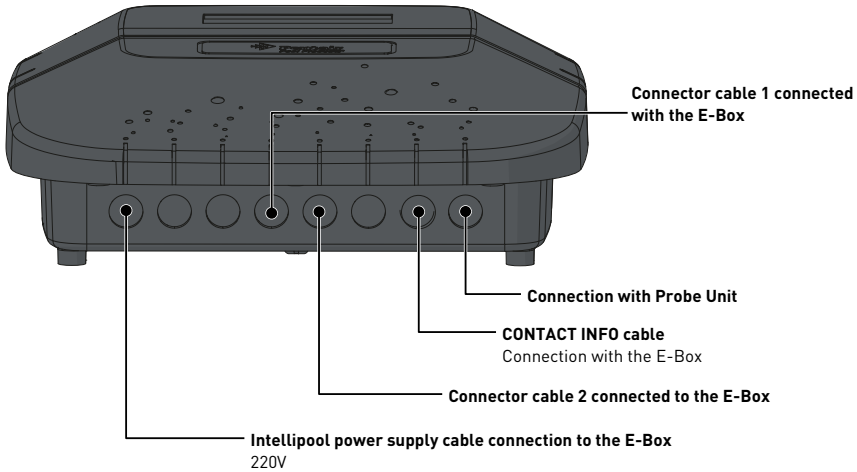

Connections to be made to the Control Centre box, through the fast cables (provided).

#### Info



**No internal connections in the Control Centre cabinet**

#### 4.9.4.3 Connections of the probes (pH + RedOx + conductivity + temperature)

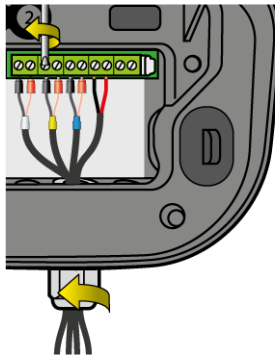

1. Unscrew the cable gland completely: be careful not to drop the black flexible seal.
2. Pass the 4 cables through the nut and the cable gland.
3. Connect each terminal according to the indication under each terminal block.
4. Screw with a 2.5 mm slot screwdriver to 0.5-0.6 N.m.
5. Tighten the cable gland tightly by hand.

**Info**



Only the Pentair probes are compatible and guarantee the proper functioning of the device.

## 4.10 4X Extension Unit

### 4.10.1 Menu installation 4X Extension

**Info**



The menu is only accessible through the website. See Website and Home Automation Control Application [->Page 8].

1. Select properties > Pool properties.
  2. In the page that appears, press the button 4X (InAux) - Install menu.
- ⇒ The Menu installation 4X Extension appears:

**Check to access all drop-down menu options**

**Customisable names**

**Inputs**

Input 1	Disabled	In 1
Input 2	Disabled	In 2
Input 3	Disabled	In 3
Input 4	Disabled	In 4

Show all options

**Outputs**

Aux 2	Filling	Filling
Aux 3	Solar heating	Solar heating
Aux 4	Filter clean	Filter clean
Aux 5	Aux	Cascade

Show all options

**Output parameters**

Filter clean duration: 0m 10s

Max filling rate Aux 2: 0h 0m

Delay Aux 2: OFF min.

Offset temperature Aux 3: + 3 °C

Save modifications

**Dropdown 1 (Inputs):**

- ORP (RedOx) Tank
- Disabled
- pH Tank
- ORP (RedOx) Tank**
- Stop filtration NO
- Stop filtration NC
- Water level too low NO
- Aux2 (status)
- Aux3 (status)
- Aux4 (status)
- Aux5 (status)

**Dropdown 2 (Outputs):**

- Aux
- Disabled
- pH
- Filtration
- If filtration ON & pool cover
- Filling
- Solar heating
- Filter clean
- Aux**
- Aux filtration activation

## 4.10.2 Examples of connections of IN inputs

### Input IN1 (terminal block 31-32)

1. In the menu "Pool Properties > Menu Installation 4X Extension", see **Menu installation 4X Extension** [→Page 47], select the related input "**pH Tank or RedOx**" and customise the name if necessary.

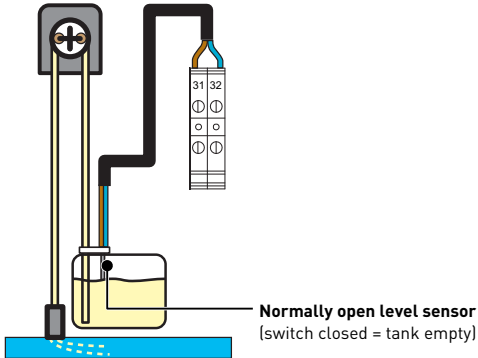

### Connection of a roller shutter limit switch

1. Connect the limit switch directly to the selected input. Example Input IN 2 (terminal blocks 33-34).
2. In the menu "Pool Properties > Menu Installation 4X Extension", see **Menu installation 4X Extension** [→Page 47], select the input "**Roller shutter**" and customise the name if necessary.

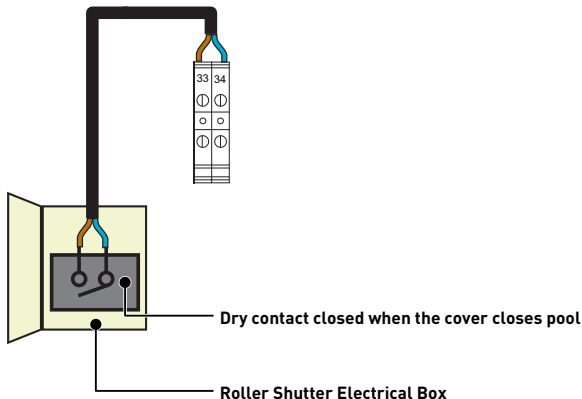

### Connecting an element before you turn off the filtration (NO or NF)

1. Connect the switch directly to the selected input. Example Input IN 2 (terminals 35-36).
2. In the "Pool Properties > Menu Installation 4X Extension" menu, see **Menu installation 4X Extension** [→Page 47], select the "**Stop NO or NF filtration**" and customise the name if necessary.



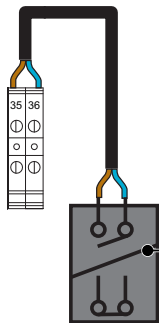

**Dry contact Normally Open or Normally Closed depending on choice:**  
 NO = Normally Open = allows filtration (closing it will immediately stop filtration)  
 NF = Normally Closed = allows filtration (opening it will immediately stop filtration)

### Connecting a component to launch an Auxiliary (X)

1. Connect the information socket contact directly to the chosen input (example terminals 37-38).
2. In the menu "Pool Properties > Menu Installation 4X Extension", see **Menu installation 4X Extension** [→Page 47], select the input "**Aux X (Status)**" and customise the name if necessary.

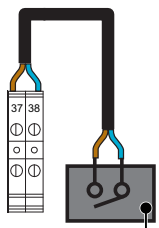

**Dry contact whose closing will trigger the launch of the selected Aux**

### Connection of a piece of equipment in order to measure its activity time in the history.

1. Connect the contact directly. If the device does not have a contact, connect to a relay according to Diagram 1bis.
2. In the menu "Pool Properties > Menu Installation 4X Extension", see **Menu installation 4X Extension** [→Page 47], select the input "**IN info 1 (terminal blocks 31-32) or 2 (terminal blocks 33-34)**" and customise the name if necessary.

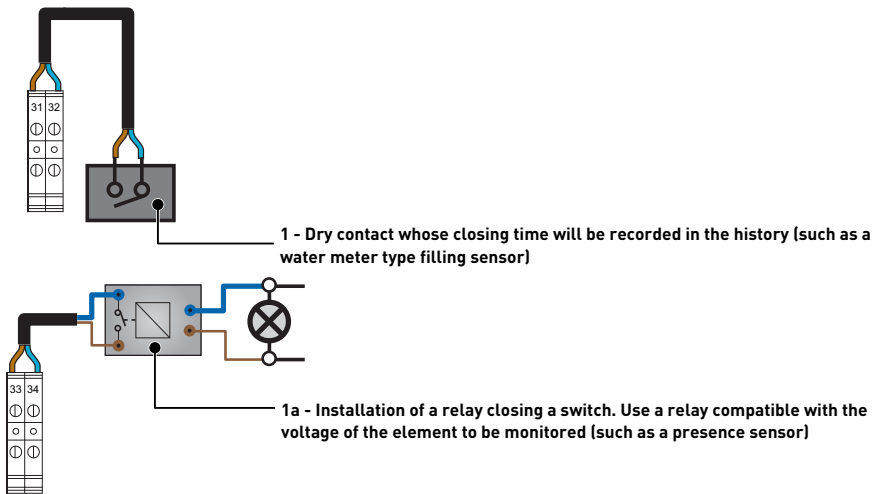

**Connection of a flow sensor (for example that of the analysis chamber)**

1. Connect the contact directly.
2. In the menu “Pool Properties > Menu Installation 4X Extension”, see **Menu installation 4X Extension [→Page 47]**, select the input “Flow Detector” and customise the name if necessary.

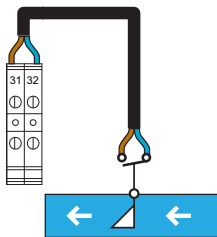

**4.10.3 AUX output connections**

**Info**

**i** The outputs (AUX 3 “Terminal blocks 25-26”, AUX 4 “Terminal Blocks 27-28” and AUX 5 “Terminal Blocks 29-30”) are dry contacts and do not provide any voltage.

**Connection of a pH/flocculant/algicide pump**

1. Connect the 230 V AC or 24 V DC peristaltic pump according to the corresponding diagram.
2. In the menu “Pool Properties > Menu Installation 4X Extension”, see **Menu installation 4X Extension [→Page 47]**, select the output “pH” and customise the name if necessary.

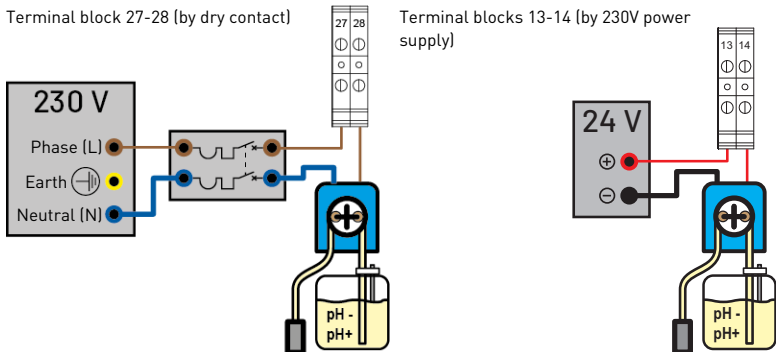

**Connecting an additional pump or apparatus >12A at 230V**

1. Connect it according to the diagram below on the output AUX 3 terminal blocks 11-12.
2. In the menu "Pool Properties > Menu Installation 4X Extension", see **Menu installation 4X Extension** [→Page 47], select the output "filtration" if you wish to activate it during pool filtration and customise the name if necessary.

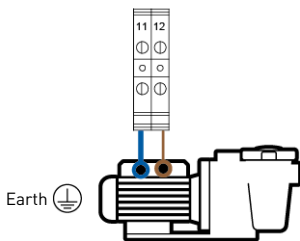

**Connecting a Pneumatic Push/Pull Valve for Filter Washing**

1. Connect the valve according to the diagram below.
2. In the menu "Pool Properties > Menu Installation 4X Extension", see **Menu installation 4X Extension** [→Page 47], select the output AUX 4 "Filter Wash" and customise the name if necessary.

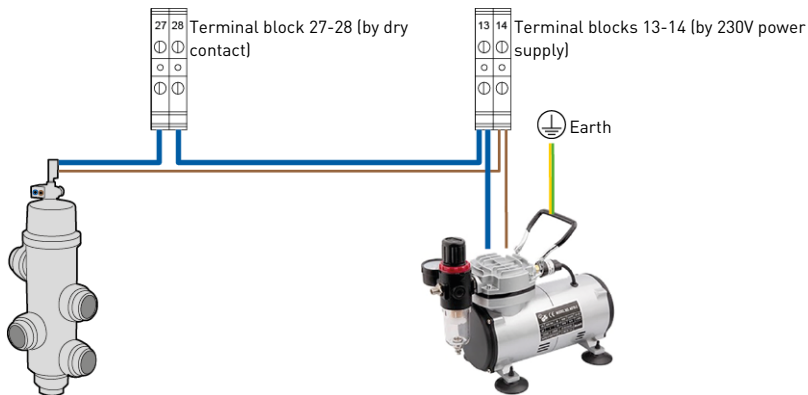

### Connecting a 3-way valve to the Control Centre (for fountain triggering...)

1. Connect the valve according to the diagram below.
2. In the menu "Pool Properties > Menu Installation 4X Extension", see **Menu installation 4X Extension** [→Page 47], select the output "Aux 4" and customise the name if necessary.

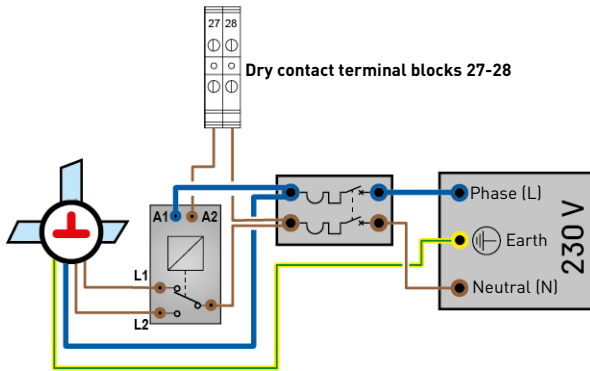

### Connecting a UV sterilizer

1. Connect the UV tube according to the diagram below by choosing the dedicated output (AUX4, AUX5).
2. In the "Pool Properties > Menu Installation 4X Extension" menu, see **Menu installation 4X Extension** [→Page 47], select the output AUX 4 "Si filtration ON" and customise the name if necessary. The UV sterilizer is active as soon as the main filtration works.

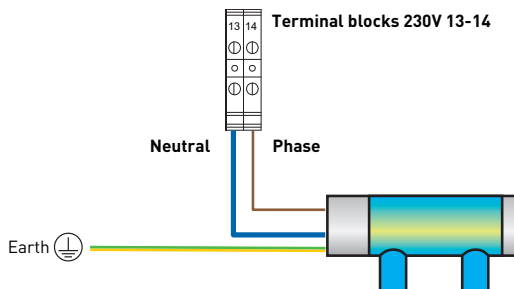

### Connection of secondary lighting (garden, atmosphere) with a power of less than 1600 W

#### Info



The main pool lighting must be connected directly to the E-Box.

1. Connect the lighting according to the diagram below.
2. The operation of this lighting control will be the same as that of the swimming pool lighting through the terminal blocks 21-22.

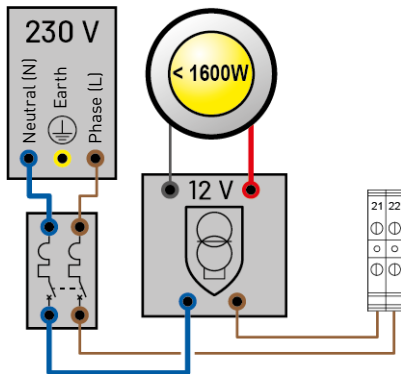

**Pool lighting independent connection**

1. Connect the additional lighting according to the diagram below, terminal blocks 13-14 (230 V / 10 A Max).
2. In the menu "Pool Properties > Menu Installation 4X Extension", see **Menu installation 4X Extension** [→Page 47], select the output AUX 4 "AUX" and customise the name if necessary. Lighting will be active when scheduling or when the switch is operated through the application.

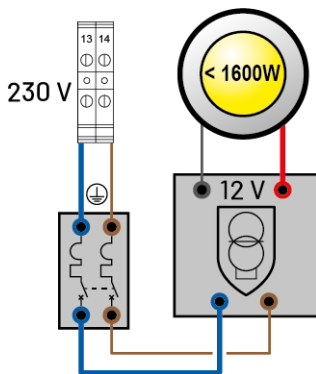

**Connection of an electric heater**

1. Connect the heater according to the choice of the diagram below (greater than or less than 10 A).
2. In the menu "Pool Properties > Menu Installation 4X Extension", see **Menu installation 4X Extension** [→Page 47], select the output "Heater" and customise the name if necessary.

**< 10A through terminal blocks (25-26 Aux3, 13-14 Aux4 or 15-16 Aux5)**

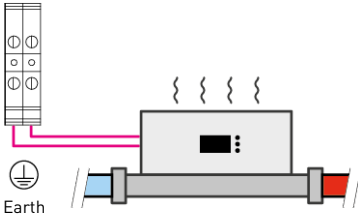

**> 10A through terminal blocks 23-24**

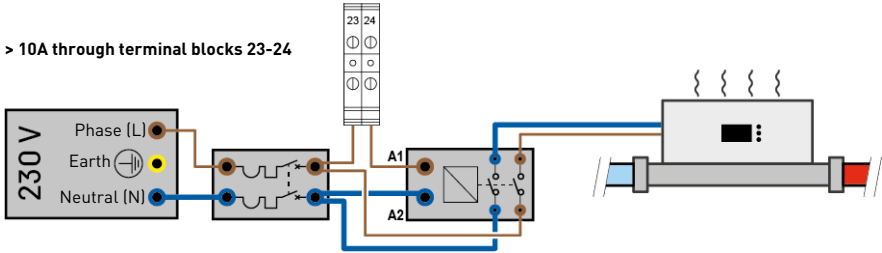

**Connecting a Solar Heater**

1. Connect the solar heater according to the choice of the diagram below.
2. Connect the solar heater temperature probe to terminals 43-44.
3. Connect the three-way valve opening control to terminals 25-26 (AUX 3).
4. In the menu "Pool Properties > Menu Installation 4X Extension", see **Menu installation 4X Extension** [→Page 47], select the output AUX 3 "Filter Wash" and customise the name if necessary.

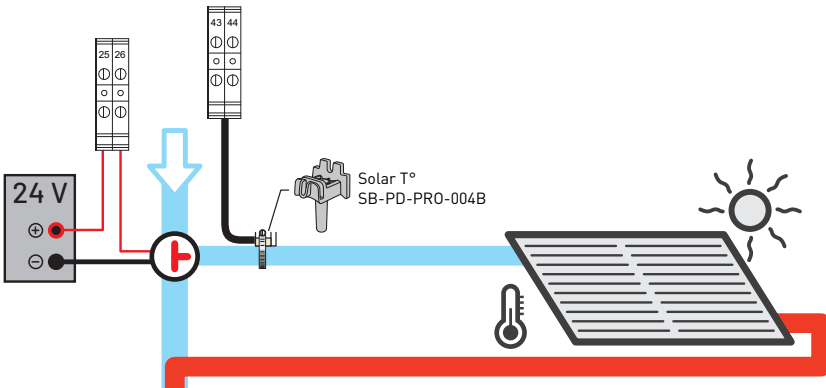

**Connecting a water level regulator too low (Normally Open N.O.)**

1. Connect the sensor and the filling solenoid valve according to the choice of the diagram below.

2. In the menu "Pool Properties > Menu Installation 4X Extension", see **Menu installation 4X Extension** [→Page 47], select the output AUX 2 "Filling" and customise the name if necessary.
3. Connect the filling solenoid valve (24 V) to terminal blocks 45-46.
4. Connect the level sensor to the input IN 1 (or 2 or 3 or 4) and then, through the installation menu, select the "water level NO" input.

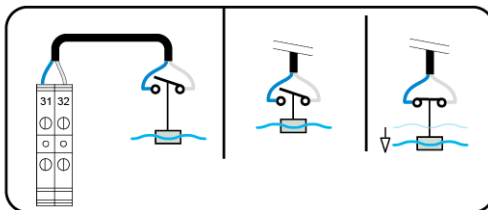
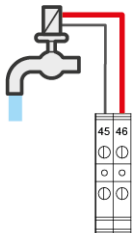

### PENTAIR IntelliFlo VSF

#### Info



Set the appropriate speeds that is, Speed 1 (Frost Free), Speed 2 (Eco), Speed 3 (Normal) and Speed 4 (Max), through the app in the "Intelliflo" tab.

**Not supplied:** the control cable.

#### IntelliFlo PENTAIR Speed Adjustment

- **Frost free:** Outlet used to trigger filtration for a water temperature < +3°C (modifiable).
- **Eco Speed:** Speed used when no preselected event (see relevant menu) is active.
- **Normal speed:** Speed used for the purposes of a preselected event (see relevant menu).
- **Maximum speed:** Speed used for backwashing or "shock" treatment (24 h of filtration and electrolyser).

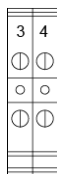

Phase/Neutral power supply in the E-Box  
Terminals 3 and 4  
The Earth on the dedicated terminal block



IntelliFlo control  
Dedicated terminal  
block 47 (+)/48 (-)



### 4.10.4 Settings done on www.intellipool.eu

#### Info



Once the Intelliflo pump is connected and powered on through the Intellipool, log into its Intellipool account to perform the Intelliflo pump speed setting.

The swimming pool concerned then receives a new "Intelliflo" submenu.

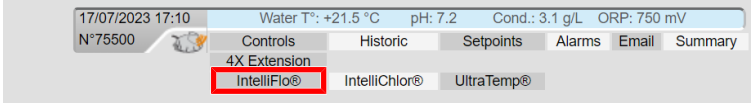
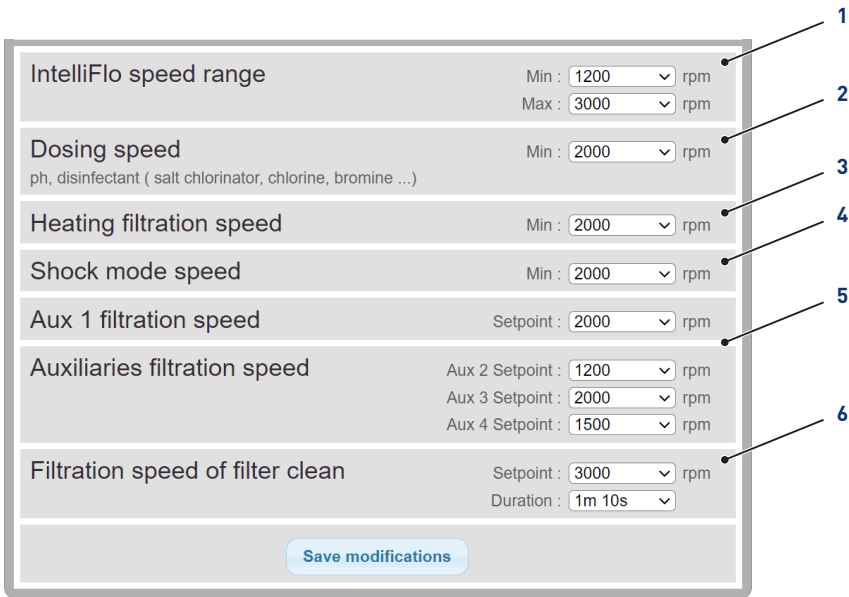

Illustration 1: Scre\_Intelliflo\_Connection



**1 Adjustment of the amplitude of the speeds.**

Minimum speed = frost free speed

**2 Filtration speed = speed activated during processing**

**3 Heating speed = speed activated during heating**

**4 Speed triggered when the cover is put in place**

Change in speed due to air temperature

**5 Speeds attributed to various auxiliary outputs**

**6 Speeds attributed to washing the filter and setting the washing time**



## 5 Programming

### 5.1 Programming the INTELLIPOOL Control Centre

#### 5.1.1 Presentation

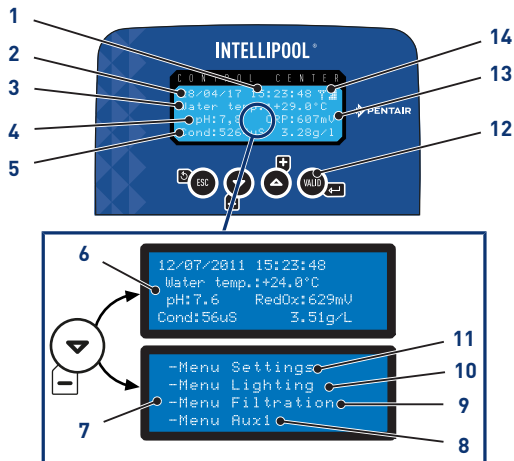

**1 Time**

**2 Date**

**3 Water temperature**

**4 Measured pH value**

**5 Conductivity value measured in  $\mu\text{S}$  and g/l**

**6 Home Screen**

Alternating screen

**7 Access to menus**

Alternating screen

**8 Settings menu**

Setting menu [→Page 58]

**9. Lighting menu**

Lighting menu [→Page 61]

**10. Filtration menu**

Filtration menu [→Page 61]

**11. Aux1 Menu**

Invisible if Aux1 is programmed in auto backwash

Aux1 Menu [→Page 62]

**12. Navigation keys**

Navigation keys [→Page 58]

**13. RedOx value measured in mV**

**14. Radio Signal Strength**

### 5.1.1.1 Navigation keys



#### Exhaust

Go back to the previous step without considering the changes.



#### Displacement down/decrementation

Navigation down in drop-down menus or decrementation of values in numerical spaces.



#### Displacement up/incrementation

Upward navigation in drop-down menus or incrementing values in numerical spaces.



#### Validation

Allows access to the parameter displayed or validates the changes and returns to the previous menu.

Hold 4 s

#### History Menu

Allows access to the history menu.

History Menu [[→Page 63](#)]

### 5.1.2 Setting menu

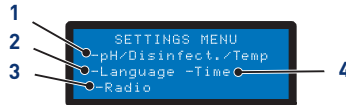

- |   |   |
|---|---|
| <p><b>1. pH Regulation/Disinfectant/Temperature</b><br/>pH Regulation/Disinfectant/Temperature<br/>[<a href="#">→Page 58</a>]</p> | <p><b>3. Radio Menu</b><br/>Radio Menu [<a href="#">→Page 59</a>]</p> |
|---|---|

- |   |   |
|---|---|
| <p><b>2. Language and Unit Menu</b><br/>Language and Unit Menu [<a href="#">→Page 59</a>]</p> | <p><b>4. Date/Time Setting</b><br/>Date/Time Setting [<a href="#">→Page 60</a>]</p> |
|---|---|

1. Select the setting menu option with and .
2. Press to confirm the selection.

#### 5.1.2.1 pH Regulation/Disinfectant/Temperature

##### pH regulation

Options:

- Auto: Automatically adjust according to pH.
- Off: Turn off the power to the pH regulator completely.
- Choice of pH+/pH-: Type of corrector (pH+ or pH-).
- Instruction: Change the pH value.
- Priming: and pressing manually triggers the connected pump.

## Disinfectant

Options:

- Auto: Automatically adjust based on RedOX.
- Off: Turn off the power to the electrolyser completely.
- Instruction: Change the RedOx value to be reached in Auto mode (650 mV factory).

## Temperature

Options:

- Auto: Temperature automatically managed.
- Off: Permanently turn off the heating.
- Instructions: Change the value to be reached.



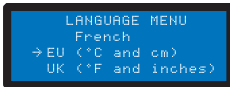



### 5.1.2.2 Language and Unit Menu



Allows you to select the displayed language and unit.

## Options

- Languages:
  - French;
  - English;
  - German;
  - Dutch;
  - Spanish;
  - Italian.
- Units:
  - EU (°C and cm);
  - UK (°F and inch).

1. Select the language with  and .
2. Press  to confirm the selection and proceed to the next parameter.
3. Select the unit with  and .
4. Press  to confirm the selection.

### 5.1.2.3 Radio Menu



The radio menu allows you to select one of the following menus:

- Memo. Installation;
- Memo. Remote control;
- Remote controls reset to zero.

1. Select the radio menu option with and .
2. Press to confirm the selection and proceed to the next parameter.

### Memo. Installation

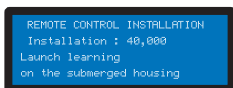

The menu asks to start learning on the immersed case.

### Tip



This operation can also be carried out from the interior display by carrying out a to-and-fro movement of the switch.

- On the back of the Inner Display, ON > Calib > ON:

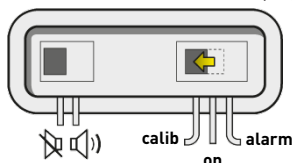

### Memo. Remote control

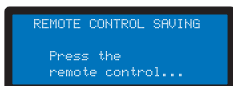

This menu is used to register a new remote control in the radio network.

The following messages may appear when registering a new remote control:

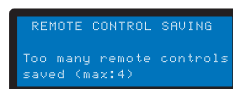
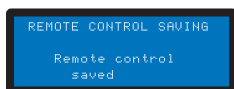

### Remote Controls Reset

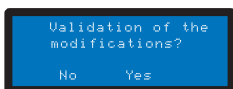

This menu is used to clear all remote controls on the network.

### 5.1.2.4 Date/Time Setting





Allows you to set the date and time.

1. Select the day with and .
2. Press to confirm the selection and proceed to the next parameter.

### 5.1.3 Lighting menu

**Options:**

- Manual: Have access to lighting through the remote control.
- Clock: Set the time slots in the Clock Setting sub-menu.
- Off: Permanently turn off the lighting.

1. Select lighting mode with  and .
2. Press  to confirm the selection.

### 5.1.4 Filtration menu

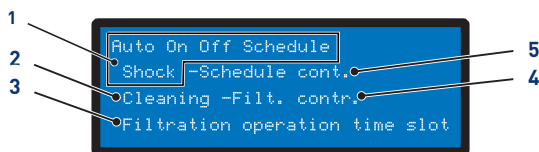

**1. Mode selection in progress**

- **Auto:** Automatically calculates filtration time based on water temperature
- **On:** Filtration runs 24 hours a day
- **Off:** Filtration is stopped (be careful, the frost-free mode becomes inactive)
- **Clock:** Filtration will work in each time range selected in the Setting menu

**2. Filter cleaning assistance**

- **Shock:** The **Shock** function triggers 24 HOURS of filtration and forced electrolysis. This function can be useful after a high attendance of the pool and a high temperature in the pool. At the end of the **Shock**mode, the INTELLIPOOL switches back to **Auto**

**3. Filtration range**

- Filter cleaning assistance [->Page 62]
- This menu makes you master of the start time and the end time of the filtration in order to control the noise pollution related to your pool (noise of the filtration) vis-à-vis the neighborhood. By default, leave **End** on **Auto**
- By checking one of the priorities, you agree that this one controls the filtration outside the authorized time slots (because these equipment require to operate when the filtration is on). If necessary, the filtration is restarted in one-hour cycles until the desired setpoint value is obtained
- In **Auto**, INTELLIPOOL calculate the filtration end time

#### 4. Filtration Settings

- This setting increases or decreases the filtration time to compensate for pump size and/or activity in the pool
- Factory settings (editable in the Installation menu):
  - Turbo = +30%
  - Eco = -30%

#### 5. Filter Clock Setting

1. Select the filter menu option with and .
2. Press to confirm the selection.

##### 5.1.4.1 Filter cleaning assistance

✓ Filtration menu selected.

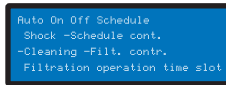

1. Press twice then to select "Wash".
  - ⇒ Filter cleaning assistance is selected.

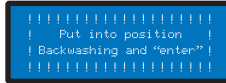



2. Select *Stop Filtration > Turn to Wash + "enter" position.*
3. Set the 6-way valve to Wash then press .
  - ⇒ Washing in progress.
4. Select *Stop Filtration > Turn to Rinse + "enter" position.*
5. Set the 6-way valve to Rinse then press .
  - ⇒ Rinsing in progress.
6. Select *Stop Filtration > Set Filtration + "enter" .*
7. Set the 6-way valve to Filtration then press .
  - ⇒ Filtration in progress.

##### 5.1.5 Aux1 Menu

###### Options:

- Manual/Clock/Off;
- Timer: 10';
- Timer settings.

### 5.1.6 History Menu

1. Access the secure menu history of the day INTELLIPOOL by pressing  for 4 secs.
2. Access the 4 pages of the history of the day by pressing on  :

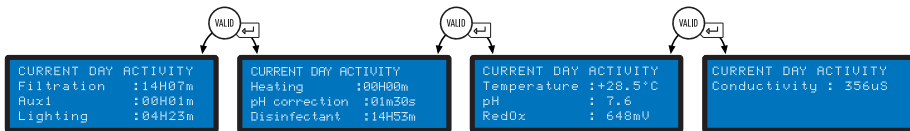

3. Access the D-1 history by pressing -  then  to view the other 3 pages:

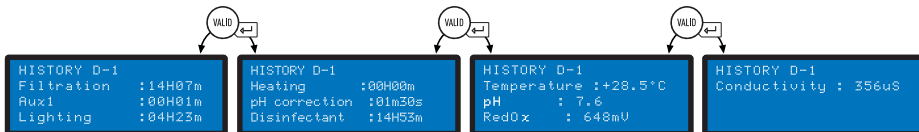

4. Access the D-2 history by pressing -  then  to view the other 3 pages...

### 5.1.7 Installation menu

Access to the installation menu is secure.

From the settings menu, press  and  simultaneously for 3 s.

This menu allows the installer to customise the settings according to the specificities of the installation.

Changing these parameters can have serious consequences on the basin. It is advisable to have your settings checked by a professional.

#### Options:

- Electrolysis/Other;
- Filtration installation;
- pH installation;
- Disinfectant installation;
- Aux1 installation;
- Default values.

#### 5.1.7.1 Electrolysis/Other

Select the type of disinfectant chosen. Other corresponds to a treatment by metering pump (bromine, chlorine, active oxygen, etc.)

#### 5.1.7.2 Filtration installation

#### Options:

- Excluding frost (default +3°C): Allows you to change the minimum temperature of the water from which filtration is forced.

- Eco (default -30%): Decreases the filtration time (in %) from the normally calculated time.
- Turbo (default +30%): Increases the filtration time (in %) of the normally calculated time.

### 5.1.7.3 pH installation

Modification of the injection parameters of the pH regulator.

#### Options:

- Injection time (default 15 s): Duration of each sequence of injection of the corrector carried out every 15 minutes by the pH pump.
- Min Temperature (default 16°C): Temperature below which the pH corrector is not injected.
- Max day volume (default 0.5 l): Maximum permissible pH regulator injection volume (for a pump with a flow rate of 1 l/h) in order to protect against possible overdose.

### 5.1.7.4 Disinfectant installation

Modification of the disinfectant injection parameters other than an electrolyser (injection of bromine, active oxygen).

#### Options:

- Injection time (default 15 s): Time of each disinfectant injection sequence.
- Min Temperature (default 14°C): Temperature below which the disinfectant is not injected or the electrolyser is stopped in order to limit the wear of the plates.
- Max day volume (default 0.5 l): Maximum permissible volume of disinfectant injection (for a pump with a flow rate of 1 l/h) to protect against possible overdose.

### 5.1.7.5 Aux1 installation

Choose Aux1 settings.

#### Options:

- Robot mode (default No): Select **Yes** to assign the AUX1 output to a robot cleaner.
- Backwash mode (default Yes): Select **Yes** to control a pneumatic backwash push pull valve.
- Fixed speed (to be set in the Intelliflo menu).



## 5.2 Inner Display Programming

### 5.2.1 Presentation

The remote Inner Display informs of all parameters (updated every 15 minutes) of water quality and comfort (temperatures, UV).

Intended for inner use, pre-programmed alerts make it possible at a glance to check the chemical balance of the water without making the tedious analyses at the edge of the basin.

Moving the display may cause signal loss. If there is more than 1 hour out of reach, the information is all erased.

The remote display can be used:

- put it on its tripod;
- attach to the wall (after testing the range of the signal).

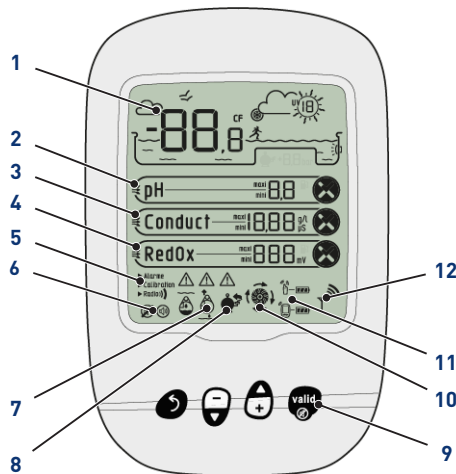

- |  |  |
|--|--|
| <p><b>1 Air/water temperature display</b><br/>Air/water temperature [→Page 66]</p> <p><b>2 pH trend</b><br/>pH trend [→Page 68]</p> <p><b>3 Conductivity Trend</b><br/>Conductivity Trend [→Page 69]</p> <p><b>4 RedOx Trend</b><br/>RedOx Trend [→Page 71]</p> <p><b>5 Mode in progress</b><br/>Alarm/calibration/radio<br/>Mode in progress [→Page 72]</p> | <p><b>7 Out-of-water probes</b><br/>Out-of-water probes [→Page 78]</p> <p><b>8 Filter wash alert</b><br/>Wash filter to do</p> <p><b>9 Navigation keys</b><br/>Navigation keys [→Page 66]</p> <p><b>10 Filtration Status</b><br/>On = Running</p> <p><b>11 Battery level</b><br/>Remote radio/display relay<br/>Battery level [→Page 79]</p> |
|--|--|

**6 Audible Alarm Status**

On/off

Audible Alarm Status [→Page 78]

**12 Radio Signal Strength**

Radio Signal Strength [→Page 79]

**5.2.1.1 Navigation keys**

**Info**

**i** Pressing any key stops an audible alarm.



**Exhaust**

Go back to the previous step without considering the changes.



**Displacement down/decrementation**

Navigation down in drop-down menus or decrementation of values in numerical spaces.



**Displacement up/incrementation**

Upward navigation in drop-down menus or incrementing values in numerical spaces.



**Illumination on/off**



**Validation**

Allows access to the parameter displayed or validates the changes and returns to the previous menu.

**5.2.2 Air/water temperature**

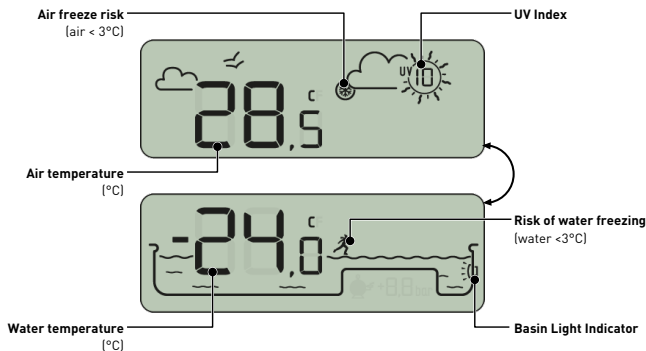

### 5.2.2.1 Temperatures

The Inner Display provides the temperature in °C):



The air temperature accompanied by the pictogram

e.g.: The air temperature is 28.5°C



The water temperature accompanied by the pictogram

e.g.: The water temperature is 24.0°C

#### Info



**Adherence to the North-South orientation of the Radio Relay improves the accuracy of air temperature measurement.**

If the installation includes two Radio Relays, the one whose jumper is ON will provide these values, see **Adding a Radio Relay and/or Inner Display** [[→Page 80](#)]. In the event of an offset between a displayed temperature value and the reference value provided by a standard device, it is possible to recover this offset through the "calibration" menu, see **Calibration mode** [[→Page 75](#)].

### 5.2.2.2 Detection of the risk of frost (water and air)

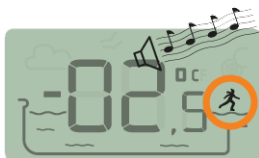

The air temperature is -2.5°C

The water freeze pictogram is displayed if the water temperature is below +3°C. There is a risk of ice formation, it is necessary to intervene to avoid damage on the pool and on the hydraulic installation.

- active wintering: force the pump to fight against the formation of frost, the probes can then remain in the water. This frost-free function is automatic when INTELLIPOOL is paired with the INTELLIPOOL Probe Unit.
- passive wintering: take the probes out of the bypass and replace the probes on the probes for their preservation. The Inner Display will then display measured values in the water of the protective cushions.

*For more details, see the chapter "Wintering of your pond".*



The gel pictogram related to the air temperature is displayed if the temperature measured by the Radio Relay is less than +3°C.

The water temperature is 0.5°C

### 5.2.3 pH trend

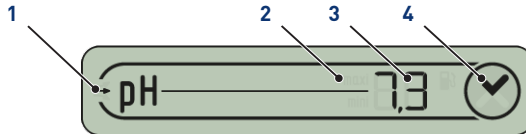

1. **pH trend (update every 2h)**
  - ↗ the pH rises
  - → the pH is stable
  - ↘ the pH drops
2. **The pH has reached alarm value**
  - [maxi] the pH has reached the maximum alarm value (factory pre-set at 6.7 can be modified through the alarm menu, see Alarm mode [→Page 72])
  - [mini] the pH has reached the minimum alarm value (factory pre-set at 7.9 can be modified through the alarm menu, see Alarm mode [→Page 72])
3. **Measured pH value**
  - Limited display between 0 and 9.9
  - Display out-of-limit value:
    - L □ pH < 0
    - H □ pH > 9.9
4. **Alarm setpoint compliance**
  - ✓ pH according to alarm setpoints (factory pre-set from 6.7 to 7.9)
  - ✗ pH outside the alarm setpoint values ("min" and "max" indicate if the value is too low or too high)

The pH is a quantity (without units) measuring the acidity (0 to 7) or alkalinity (7 to 14) of the basin. The pH is the concentration of hydrogen ions. For a swimming pool, the ideal pH generally recommended is close to 7.3 (to be confirmed with your pool owner depending on your installation).

#### Tip



**The accuracy of the pH measurement is related to the regular maintenance of the pH probe. It is advisable to check it regularly for any contamination (see Cleaning the pH or RedOx probe [→Page 87]) and to calibrate it before the summer season (see Calibration mode [→Page 75]).**

**Info**



The set values of the high and low pH alarms are factory pre-set to 6.7 and 7.9. These values can be modified through the alarm mode (see Alarm mode [→Page 72]).

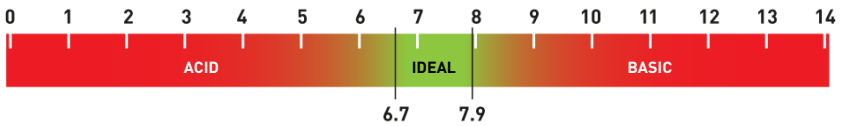

**CAUTION**



**pH too high or too low!**

Skin irritation

- ✓ Ensure that:
  - ✓ the cylinder has been removed from the pH probe (see Installation of probes [→Page 42])
  - ✓ the pH probe was calibrated less than 6 months ago (see Calibration mode [→Page 76])
  - ✓ pH probe is not clogged (see Cleaning the pH or RedOx probe [→Page 87])
    - manual regulation: put the product "pH-" or "pH+" according to the pH drift.
    - automatic regulation: check the proper functioning of the equipment.

If the pH value is Hi or Lo, check that an air bubble at the bottom of the pH probe does not distort the measurement. Shake the device (like a mercury thermometer) so that, by centrifugal force, any air bubble rises.

**5.2.4 Conductivity Trend**

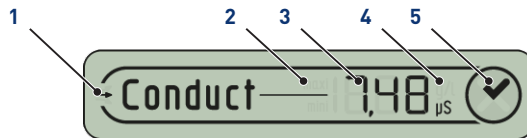

1. **Conductivity trend (updated every 2 hours)**
  - ↘ conductivity rises
  - conductivity is stable
  - ↙ conductivity decreases
2. **Conductivity has reached alarm value**
  - maxi the conductivity has reached the maximum alarm value (factory pre-set at 50 µS, can be changed on the alarm menu, see Alarm mode [→Page 72])
  - mini the conductivity has reached the minimum alarm value (factory pre-set at 1200 µS, can be changed on the alarm menu, see Alarm mode [→Page 72])

### 3. Value of measured conductivity

- display limited between 0 and 1999
- value out of display limit:
  - $L$  □ Conductivity < 0 g/l
  - $H$  □ Conductivity > 19.99 g/l



### 4. Unit used

- g/l unit used for salt electrolysis
- $\mu$ S unit used without salt electrolysis

The choice of the conductivity unit ( $\mu$ S or g/l) is made by the mode calibration/change of units [see Calibration mode [→Page 75]].

If the display uses  $\mu$ S as the unit of measurement and the value rises above 1999  $\mu$ S, it will automatically switch to g/l. Tap water has a conductivity generally between 300 and 600  $\mu$ S in France.

### 5. Alarm setpoint compliance

-  conductivity in accordance with alarm setpoints (factory pre-set from 50  $\mu$ S to 1200  $\mu$ S)
-  conductivity outside the alarm setpoint values ("min" and "max" indicate if the value is too low or too high)

Conductivity is the ability of a water to allow the passage of electric current, conductivity is proportional to the concentration of dissolved minerals (derived in part from water treatment products).

#### Info



**The value in  $\mu$ S reveals "the age of the water in the basin".**

**MS/ g/L match: 1000  $\mu$ S = 0.63 g/L and 1 g/L = 1587  $\mu$ S.**

Conductivity at 25°C ( $\mu$ S/cm)	Estimated TH	Water hardness classification
<300	<17	Freshwater
Between 300 and 550	Between 17 and 30	Hard water
Between 550 and 950	Between 30 and 55	Very hard water
>950	>55	Extremely hard water

- Conductivity in a salt electrolysis tank (in g/l)
  - the conductivity is too low (depending on the type of electrolyser): add salt up to the value recommended by your electrolyser.
  - the conductivity is too high (depending on the type of electrolyser): renew the water in the basin (emptying + filling) until the desired value is obtained
- The conductivity in a pool without salt electrolysis (in  $\mu$ S/cm)
  - The conductivity is too high (>1200  $\mu$ S, modifiable default alarm value): renew the pool water (drain + fill) until a value of less than 1200  $\mu$ S is obtained. A water with a conductivity greater than 1200  $\mu$ S is called "buffered", the treatments then become ineffective.

**Info**



A zero (or close to zero) conductivity value indicates the presence of air in the probe tube.

**5.2.5 RedOx Trend**

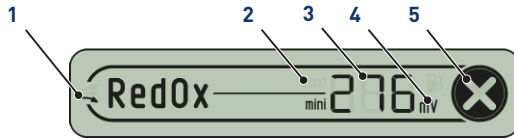

- |   |  |
|---|--|
| <p><b>1. RedOx Trend (Updated every 2h)</b></p> | <ul style="list-style-type: none"> <li>• ↗ the RedOx</li> <li>• → redOx is stable</li> <li>• ↘ the RedOx decreases</li> </ul>  |
| <p><b>2. RedOx has reached alarm value</b></p>  | <ul style="list-style-type: none"> <li>• <span style="border: 1px solid black; padding: 2px;">maxi</span> the RedOx has reached the maximum alarm value (factory pre-set at 800 mV modifiable through the alarm menu, see Alarm mode [→Page 72])</li> <li>• <span style="border: 1px solid black; padding: 2px;">mini</span> the RedOx has reached the minimum alarm value (factory pre-set at 550 mV modifiable through the alarm menu, see Alarm mode [→Page 72])</li> </ul> |
| <p><b>3. RedOx value measured in mV</b></p>     | <ul style="list-style-type: none"> <li>• display limited between 0 and 999</li> <li>• value out of display limit:                             <ul style="list-style-type: none"> <li>- <span style="border: 1px solid black; padding: 2px;">L</span> Conductivity &lt; -99 mV</li> <li>- <span style="border: 1px solid black; padding: 2px;">H</span> Conductivity &gt; 999 mV</li> </ul> </li> </ul>   |
| <p><b>4.  empty disinfectant tank</b></p>       | <ul style="list-style-type: none"> <li>• option on a metering pump equipped with a low level detection cannula</li> </ul>  |
| <p><b>5. Alarm setpoint compliance</b></p>      | <ul style="list-style-type: none"> <li>• <span style="border: 1px solid black; border-radius: 50%; padding: 2px;">✔</span> RedOx complies with alarm setpoints (factory pre-set 550-800mV)</li> <li>• <span style="border: 1px solid black; border-radius: 50%; padding: 2px;">✘</span> RedOx outside the alarm setpoint values ("min" and "max" indicate if the value is too low or too high)</li> </ul>  |

Concentration rate of disinfectant (chlorine, bromine, active oxygen...) present in the basin.

For this measure of "disinfection power" it is commonly advised to stay between 650 mV and 750 mV.



The oxidation-reduction potential indicates the quality of oxidant present in the water. It is the result of the ratio of the amount of disinfectant to the amount of pollution.

**CAUTION**

**A RedOx too high can damage elements of the basin!**

**A RedOx too low can be dangerous for hygiene!**

- ✓ ensure that:
  - ✓ the spigot has been removed from the RedOx probe (see Probe Unit [→Page 20])
  - ✓ the RedOx probe is not clogged (see Cleaning the pH or RedOx probe [→Page 87])
- manual regulation: Add disinfectant (chlorine, bromine, active oxygen, etc.) to the desired value.
- automatic regulation: Check the proper functioning of the equipment with your pool owner.

## 5.2.6 Mode in progress

- ▶ Alarme
- ▶ Calibration
- ▶ Radio))

The Alarm (Alarm mode [→Page 72]) and Calibration modes (Calibration mode [→Page 74]) correspond to the position of the switch on the back of the Inner Display.

The Radio mode means (Radio mode [→Page 78]) that the radio is learning a new element on the INTELLIPOOL network.

### 5.2.6.1 Alarm mode

This mode is used to modify the setpoint value of:

- the high pH alarm (factory pre-set to 7.9);
- low pH alarm (factory pre-set to 6.7);
- the high conductivity alarm (factory pre-adjusted to 1200  $\mu$ S);
- the low conductivity alarm (factory pre-adjusted to 50  $\mu$ S);
- the RedOx high alarm (factory pre-adjusted to 800 mV);
- redOx low alarm (factory pre-adjusted to 500 mV).

### Alarm setpoint modification

#### Info



**All these values remain stored when changing batteries.**

#### Info



**To reset all device defaults, press and hold (4 s) “reset” with a desktop paper clip on the back of the Inner Display. The operation is validated by a long beep.**

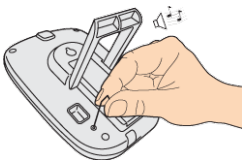



1. Place the switch in alarm mode (rear side of the Inner Display).

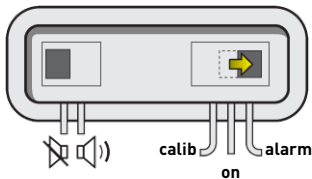





⇒ Alarm mode is selected on the Inner Display:

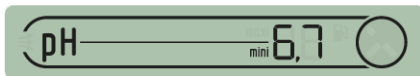



2. Press  to select the pH low alarm.





3. Press  to select the pH value .



4. Use  and  to set the pH low alarm value .

5. Press  to validate the pH low alarm value.

6. Press  to select the pH high alarm.





7. Press  to select the pH value .



8. Use  and  to set the pH high alarm value .

9. Validate the selection  to validate the pH high alarm value.

10. Press  to select the low conductivity alarm.





11. Press  to select the conductivity value .



12. Use  and  to set the conductivity low alarm value .

13. Press  to validate the conductivity low alarm value.

14. Press  to select the conductivity high alarm.





15. Press  to select the conductivity value .

16. Use  and  to set the conductivity high alarm value .

17. Validate the selection  to validate the high conductivity alarm value.

18. Press  to select the RedOx low alarm.





19. Press  to select the RedOx value .

20. Use  and  to set the RedOx low alarm value .

21. Press  to validate the RedOx low alarm value.

22. Press  to select the RedOx high alarm.



23. Press  to select the RedOx value .

24. Use  and  to set the RedOx high alarm value .

25. Validate the selection  to validate the RedOx high alarm value.

26. Return the switch to the ON mode (rear side of the Inner Display).

### 5.2.6.2 Calibration mode

Despite the calibration of the measurement sensors, it is possible that a value is offset with another measurement reference frame (usual thermometer, etc.). For this, you have the possibility to voluntarily correct certain values.

**Change of units & voluntary correction of values**

**Info**



**All these values remain stored when changing batteries.**

This mode allows you to modify the units of:

- air temperature & water temperature (factory pre-set in °C);
- the height of the water (factory pre-adjusted in cm);
- conductivity (factory pre-set in µS).

This mode is used to correct the measured values of:

- the air temperature;
- the water temperature.

1. Place the switch in alarm mode (rear side of the Inner Display).

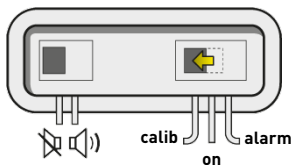

⇒ Calibration mode is selected on the Inner Display:







**Air & Water Temperature Unit [°C/°F]**



1. Press to select the air & water temperature unit .
2. Use to change the unit.
3. Press to confirm the selection.





### Air temperature correction



1. Press  to select the air temperature
2. Use  and  to set the air temperature value.
3. Validate the selection  to validate the air temperature value.





### Water temperature correction



1. Press  to select the water temperature
2. Use  and  to set the water temperature value.
3. Validate the selection  to validate the water temperature value.

### Conductivity unit (g/l or $\mu$ S)



1. Press  to select the conductivity unit
2. Use  and  to change the unit.
3. Validate the selection  to validate the conductivity unit.
4. Return the switch to the ON mode (rear side of the Inner Display).

### Calibration of a pH probe

Due to its nature, a pH probe needs to be recalibrated regularly (preferably before the season).

The pH Probe Pentair is available as a spare part from your dealer Pentair.

### Tools

- pH probe;
- Inner Display;
- standard bottles of pH4 and pH7.

### What to do

- ✓ This procedure needs to be practiced in the shade.

1. Place the switch in calibration mode (rear side of the Inner Display).

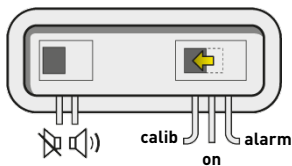

⇒ Calibration mode is selected on the Inner Display:



2. Press 5 times  to select the pH trend.

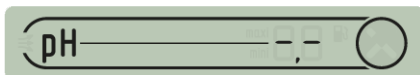

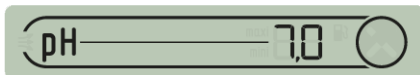

3. Validate the selection .

4. Soak the end of the pH probe in the standard solution through pH 7 for a minimum of 10 min.

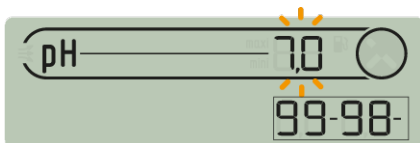

5. Press , a 99 s countdown is started:



- ⇒  Continue with the procedure (go to the next step)
- ⇒  Procedure
- ⇒ Check the presence of a pH 7 solution in contact with the probe for the duration of the procedure.
- ⇒ The probe is no longer functional (to be replaced).

6. Validate the selection .

7. Soak the end of the pH probe in the standard solution through pH 4 for a minimum of 10 min.

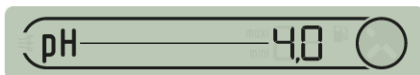

8. Press , a 99 s countdown is started:

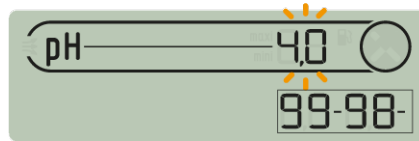

- ⇒ ☑ The procedure is complete.
- ⇒ ☒ Procedure
- ⇒ Check the presence of a pH 4.0 solution in contact with the probe for the duration of the procedure.
- ⇒ The probe is no longer functional (to be replaced).

### 5.2.6.3 Radio mode

#### Info



The elements making up a set INTELLIPOOL are paired automatically by a unique radio code which prevents any risk of interference with other INTELLIPOOL (neighbourhood...).

This RADIO mode allows you to add to an existing INTELLIPOOL:

- a no. 2 Radio Relay in order to overcome difficult radio range situations (relief, very long distances, etc.);
- an Inner Display no. 2 in order to take advantage of a second source of reading of the information of your pool.

### 5.2.7 Audible Alarm Status

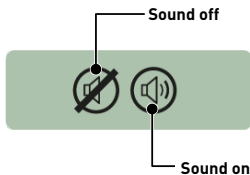

On the Inner Display, an audible alert for the various alarms as well as a discreet beep are available.

This pictogram illustrates the activation and deactivation of the sound accessible by the switch located on the back of the Inner Display.

### 5.2.8 Out-of-water probes



pHand RedOx (ORP) probes should always be soaked in water to avoid drying out.

Normally, probes are always in the water. For any reason, if air is present in the piping, check the presence of air intake as well as the proper sealing of the hydraulic circuit.

### 5.2.9 Battery level



Batteries full

Good

Very low

HS

The level of the batteries is displayed under the pictogram representing each element concerned.

Battery life is longer than 1 year but may vary depending on weather and usage conditions.

As soon as the level is at "Low Batteries", the batteries must be changed: (Radio Relay: 4 X LR6/Inner Display: 4 X LR6), see Alkaline battery replacement [→Page 89].

### 5.2.10 Radio Signal Strength

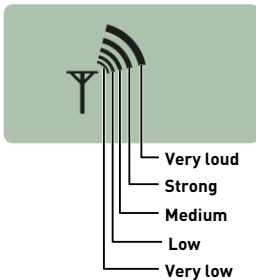

The network radio range INTELLIPOOL Probe Unit depends on the geographical set-up of the Radio Relay and of the Inner Display, the following points can reduce its good performance:

- a long distance;
- a swimming pool raised above the house;
- the presence of a perimeter wall;
- the materials of the house (reinforced concrete or metal buildings);
- the support of the Radio Relay (metal stake or galvanized rainwater downspout).

If after testing different Radio Relay location configurations the network signal is still too weak or non-existent, place a second Radio Relay between the technical room and the Inner Display in order to optimize the signal strength (perform tests before fixing the elements). Adding an element to the radio network involves learning it (see Adding a Radio Relay and/or Inner Display [→Page 80]).

## 6 Operations

### 6.1 Commissioning

Turning on

When first starting up:

- the facade panels must be installed on the E-Box;
- the light on the front of the E-Box box must be illuminated, indicating the presence of voltage;
- the Control Centre must have its screen backlit and display information relating to the various measurements of the pool water;
  - if the Control Centre is stopped and then restarted, the 4X Extension light flashes for 30 seconds before turning on continuously.

### 6.2 Adding a Radio Relay and/or Inner Display

#### Info



The elements making up a set INTELLIPOOL are paired in the factory by a unique radio code that prevents any risk of interference with other INTELLIPOOL (neighbourhood, several nearby swimming pools...).

This RADIO mode allows you to add to an existing INTELLIPOOL:

- a no. 2 Radio Relay in order to overcome difficult radio range situations (relief, very long distances, etc.).
  - an Inner Display no. 2 in order to take advantage of a second source of reading of the information of your pool.
1. Press "reset" briefly (0.5 s).

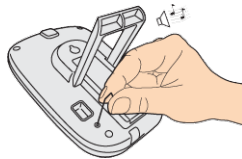

#### Caution - material



**Do not press for 4 s (until beep).**

This would trigger a reset of the alarm values (risk of loss of information).

⇒ Radio mode is selected on the Inner Display:





**Info**



**Switching on a Radio Relay or Inner Display triggers the recognition/machine learning of a radio code.**

**New Radio Relay no. 2**

1. Remove the the tub by pulling on the tab.

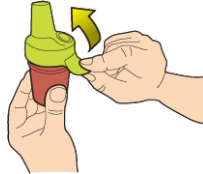

2. Place the jumper in the OFF position to avoid disturbing the outdoor temperature and UV index values of Radio Relay K no. 1, Radio Relay [→Page 22].

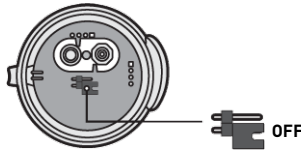

3. Remove the insulating film from the batteries.

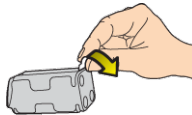

4. Reconnect the battery pack.

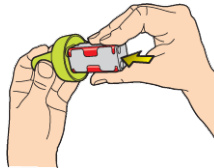

5. Raise the jar.

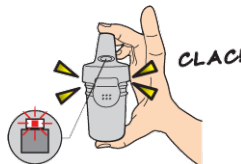

⇒ The red LED is flashing.

## New display no. 2

1. Remove the battery door.

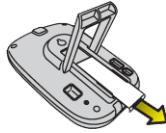

2. Remove the insulating film from the batteries.

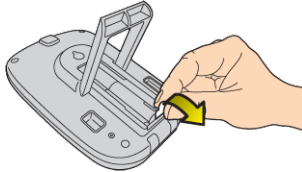

3. Inner Display no. 2 goes into radio learning mode.
4. Inner Display no. 2 displays the same values as Inner Display no. 1.
5. Replace the battery door.

### Info



If the alarm values of display no. 1 have been customised, they must be reported on display no. 2 to obtain identical alarm messages.

## 6.3 Re-learning the Original Inner Display

This RADIO mode makes it possible, in the event of loss or replacement of the original display, to recognise it in the existing network INTELLIPOOL.

1. Press "Radio Learning".
  - ⇒ The orange LED lights up, the INTELLIPOOL Probe Unit then emits a learning radio code during 5 min.

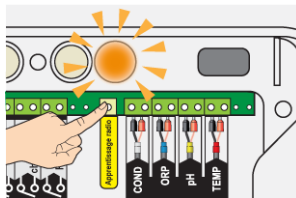

- ⇒ Turning on the Inner Display triggers the recognition/machine learning of a radio code.

2. Remove the battery door.

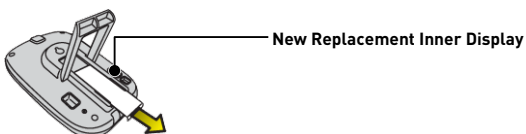

3. Remove the insulating film from the batteries.

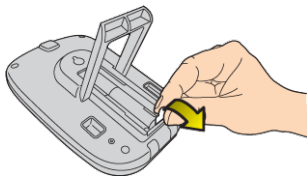

⇒ The Inner Display goes into radio learning mode.

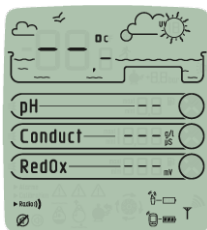

4. The Inner Display displays the values.
5. Replace the battery door.
6. Replace the orange cover on the INTELLIPOOL Probe Unit.

### 6.4 Operation of the Internet Relay

The operation of the Internet Relay is described by the color code as well as the frequency of the flashing of the LEDs below:

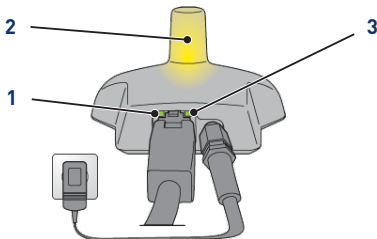

**1 Data transmission led**

Data transmission in progress (  ).

**2 Server Connection Indicator Light**

Not connected to the server (  ).

Check the power supply, Ethernet cable connection and internet connection.

Connected to server (  ).

Sending data (  ).

### 3 Grid connection led

Initialization fault or no power supply ()  
Check the connection of the power cable.

Lack of network ()

Check the connection of the Ethernet cable and check the internet connection.

DHCP resolution in progress ()

If the flashing continues, check the DHCP activation in the interface of your internet modem.

Connected to the network ()

The Internet Relay is well connected to the network.

#### 6.4.1 Home automation-pool account

The [www.intellipool.eu](http://www.intellipool.eu) allows you to always follow the settings of your swimming pool from the Internet.

1. In order to have access to your settings, connect to the site indicated above.
2. If you are new, create an account by following the steps on the screen.  
Otherwise use your usual Username.

Features and Account Type:

Account Choice	Basic	Individual	Swimming pool
Reading information <i>(pH, RedOx, Temperature)</i>	X	X	X
Comfort control <i>(heating, lighting)</i>	X	X	X
Clock setting <i>(filtration, pH or RedOx priorities)</i>		X	X
Setpoint settings <i>(pH, water temperature)</i>		X	X
Setting of setpoint parameters <i>(injection time, pump volume)</i>			X
Adjustment of installation parameters <i>(type of disinfectant, pH+ or pH-)</i>			X

The "swimming pool" account type is strictly reserved for professionals.

The serial number is located on the identification plate of the Inner Display, it is the five digits that follow the letters SN (1). This number can also be found on the last cover page of this document.

The ID-Key (2) number is a unique security code certifying the device, you can find it on the last cover page of this document.

1. The account is created, you can log in and have access to your pool settings.

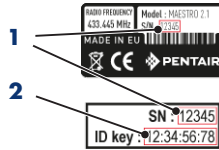

## **7 Maintenance**

### **7.1 Maintenance**

Clean the outside of the various items with a dry microfiber cloth. Do not use solvents, abrasives or acids.

### **7.2 Wintering of the INTELLIPOOL (T° water < +3.0°C)**

- Over-wintering: the forced operation of the pump prevents the formation of ice on the surface.
- passive wintering: lowering of the water level under the discharge nozzles, draining of the pipes, installation of wintering floats, installation of a shutter...

#### **Pool active overwintering**

The probes may remain in place up to a temperature greater than or equal to +3°C. of the water. If the temperature is below +3°C, there is a risk of irreversible damage to the pH and RedOx probes.

1. Be sure to keep the water temperature above +3°C (filtration activation).

If the INTELLIPOOL Probe Unit is connected to the INTELLIPOOL Control Centre, the latter integrates a frost free function.

### **7.3 pH and RedOx probes**

Deposition of scale or suspended elements in the basin may occur. The probes are fragile measuring elements, they should be cleaned carefully.

1. If foreign matter is deposited, clean the tip of the probes with a small soft brush (soft toothbrush) and then rinse them thoroughly under water (see Cleaning the pH or RedOx probe [→Page 87]).
2. If scale is deposited, immerse the tip of the probe in pure white vinegar for a minimum of 5 minutes and then rinse thoroughly under water (see Cleaning the pH or RedOx probe [→Page 87]).
3. Re-calibrate the pH probe before each season or every 6 months (see Calibration mode [→Page 76]).

## 7.4 Radio Relay and Inner Display

### Radio Relay

The Radio Relay being fixed to the outside, the appearance of traces of deposition is quite normal.

1. Clear and clean the lens of any bodies obstructing the window (sheets, stains, etc.)

### Inner Display

The Inner Display is exclusively intended for inner use. Exposure to sunlight (UV) or rain can irreversibly damage it.

1. Do not subject the device to shocks or forces that could impair the operation or limit the life of the device.
2. Do not immerse the appliance in water.
3. Clean the exterior with a micro-fiber cloth or sponge. Do not use solvents, abrasives or acids.

## 7.5 Cleaning the pH or RedOx probe

### Mandatory



**Wearing glasses is mandatory!**

### Info



**Deposition of scale or suspended elements in the basin may occur. The probes are fragile measuring elements, they should be cleaned with care, and most particularly the platinized surfaces of the electrodes of the conductivity probe should not be scratched.**

### Physical cleaning of the probe in case of presence of an element in the protective cage

Depending on the environment of the probe, organisms may develop and disrupt the measurement. It then becomes necessary to physically clean the end of the probe (pH or RedOx).

1. Carefully unscrew the protective cage by hand.

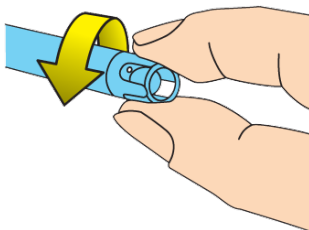

2. Using a toothbrush previously soaked in white vinegar, gently brush the tip of the probe until the foreign body is completely removed.

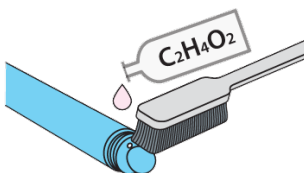

3. Rinse the tip of the probe thoroughly under running water for 5 minutes.

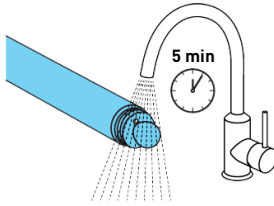

4. Screw the protective cage back on gently.
5. For pH probe only, calibrate the probe.

**Chemical cleaning of the probe (no element must be present in the protective cage)**

1. Soak the tip of the probe for at least 10 minutes in white vinegar.



2. Rinse the tip of the probe thoroughly under running water for 5 minutes.

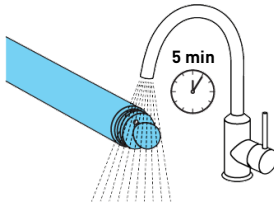

3. Calibrate the probe for pH probes only.





## 7.6 Alkaline battery replacement

The life of the batteries supplied is more than one year (depending on the conditions of use).  
New batteries must be alkaline type, do not use rechargeable batteries.

**CAUTION**



**Batteries can contain dangerous substances, they should not be thrown in the trash. Do not open them or throw them in the fire under penalty of explosion.**

Recycle batteries at appropriate collection centres.

**Info**



**Remove batteries when not in use for a long time.**

### 7.6.1 Changing the Radio Relay Batteries

**Caution - material**



**Since the Radio Relay is subjected to very high heat, it is necessary to use high-quality alkaline batteries that withstand temperatures of +70°C. (e.g. DURACELL PROCELL batteries).**

Risk of damage to the Radio Relay

- ✓ As soon as the level is at "Low Batteries", the batteries should be changed.



1. Remove the the tub by pulling on the tab.



2. Remove used batteries.

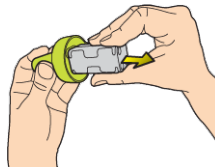

3. Insert the new alkaline batteries (4xAA) respecting the polarity indicated.

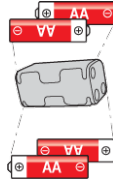

4. Reconnect the battery pack.

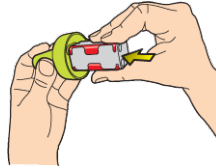

5. Red LED flashes for 10 s.

⇒ The Inner Display Radio Relay battery symbol shall indicate full batteries after 30 s.



6. Raise the jar.



### 7.6.2 Changing Inner Display Batteries

✓ As soon as the level is at “Low Batteries”, the batteries should be changed.



1. Remove the protective cover **[2]**.
2. Remove used batteries.
3. Insert the new batteries **[1]** (4 AA batteries) respecting the indicated polarities.

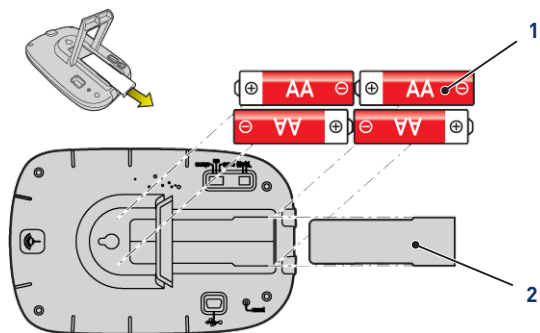

4. Check the battery power level on the Inner Display screen.
  5. Replace the protective cover [2].
- ⇒ Battery level is updating.



**Info**



**Changing the batteries does not erase the customisation of the Inner Display programming.**







**Info**

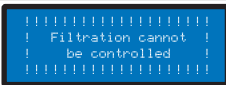

**Wait 10 s to refresh the screen display.**

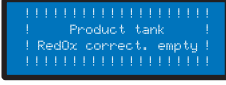
## 8 Troubleshooting

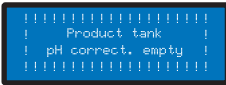
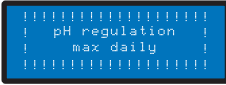
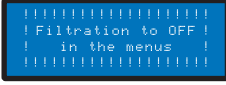

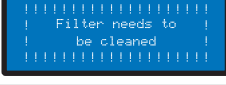
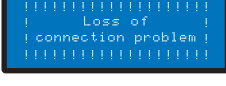

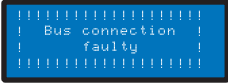



### 8.1 Alert Messages

Alert Messages	Meanings
 <pre> !!!!!!!!!!!!!!!!!!!! ! Filtration cannot ! ! be controlled ! !!!!!!!!!!!!!!!!!!!! </pre>	<p>INTELLIPOOL does not manage to stop or launch the filtration.</p> <ol style="list-style-type: none"> <li>1. Check the connections, that the 3-position switch is on Clock/Auto and the correct connection of A1A2.</li> </ol>
 <pre> !!!!!!!!!!!!!!!!!!!! ! Anti-freezing mode ! ! inactif ! !!!!!!!!!!!!!!!!!!!! </pre>	<p>If the filtration is set to Off, this message is displayed for a few seconds to inform you that the out-of-freeze is becoming inactive and alerts you to the importance of this decision.</p>
 <pre> !!!!!!!!!!!!!!!!!!!! ! Anti-freezing mode ! ! active ! !!!!!!!!!!!!!!!!!!!! </pre>	<p>The frost-free mode is in action, factory set +3.0°C (editable in the Installation menu).</p>
 <pre> !!!!!!!!!!!!!!!!!!!! ! Product tank ! ! RedOx correct, empty ! !!!!!!!!!!!!!!!!!!!! </pre>	<p>The chlorine tank is empty, this message is displayed only if it is connected to a Probe Unit INTELLIPOOL or to a In-Aux.</p> <ol style="list-style-type: none"> <li>1. Fill the tank with liquid chlorine.</li> </ol>
 <pre> !!!!!!!!!!!!!!!!!!!! ! Max daily RedOx ! ! control ! !!!!!!!!!!!!!!!!!!!! </pre>	<p>INTELLIPOOL needs to use more disinfectant than allowed in the <b>Max Daily Volume</b> (set in the factory at 0.5 l/day).</p> <p>The message clears automatically at midnight.</p>
 <pre> !!!!!!!!!!!!!!!!!!!! ! Product tank ! ! pH correct, empty ! !!!!!!!!!!!!!!!!!!!! </pre>	<p>The pH corrector tank is empty, this message is displayed only if it is connected to a Probe Unit INTELLIPOOL or to a In-Aux.</p> <ol style="list-style-type: none"> <li>1. Fill the pH corrector tank.</li> </ol>
 <pre> !!!!!!!!!!!!!!!!!!!! ! pH regulation ! ! max daily ! !!!!!!!!!!!!!!!!!!!! </pre>	<p>INTELLIPOOL needs to use more pH corrector than allowed in the <b>Max Daily Volume</b> (set in the factory at 0.5 l/day).</p>
 <pre> !!!!!!!!!!!!!!!!!!!! ! Filtration to OFF ! ! in the menus ! !!!!!!!!!!!!!!!!!!!! </pre>	<p>You try to start the filtration but in the filtration menu, the position is off.</p>
 <pre> !!!!!!!!!!!!!!!!!!!! ! Check ! ! control ! !!!!!!!!!!!!!!!!!!!! </pre>	<p>Calibrate the pH probe, Calibration mode [→Page 76].</p>
 <pre> !!!!!!!!!!!!!!!!!!!! ! Filter needs to ! ! be cleaned ! !!!!!!!!!!!!!!!!!!!! </pre>	<p>The filter must be cleaned.</p> <ol style="list-style-type: none"> <li>1. Start a filter washing procedure.</li> </ol>
 <pre> !!!!!!!!!!!!!!!!!!!! ! Loss of ! ! connection problem ! !!!!!!!!!!!!!!!!!!!! </pre>	<p>INTELLIPOOL is not connected to the radio network.</p> <ol style="list-style-type: none"> <li>1. Check the antenna of INTELLIPOOL and the state of the Radio Relay (position, batteries). A remote antenna is optionally available.</li> </ol>

Alert Messages	Meanings
	Check the connection of all connected devices on the BUS.

## 9 Spare part

Genuine parts, necessary for the maintenance of your device Pentair, are available at your dealers.

SB Item Code	Description	Diagram
INTP-5210	pH probe 50 cm cable and standard solutions pH4 & pH7	
INTP-5220	RedOx Star Probe 50cm Cable	
INTP-5230	Conductivity probe 50 cm long glass cable	
SB-PD-PRO-004B	Probe Water or air temperature 6m cable	
INTP-5160	Inner Display Only	
INTP-5150	Radio Relay only	
INTP-HOLD-2	The analysis chamber: constant flow for better measurement accuracy. 4m clear tube, 3 probe holders, 2 pick-up clamps, 2 taps	
INTP-5240	Remote antenna SMA magnetic 3 m (recommended for technical rooms disturbing the radio)	
INTP-DOS-2	Complete dosing pump	

## 10 Disposal

The appliance must be disposed of in accordance with Directive 2012/19/EU or the environmental standards in force in the country of installation. The components included in the system must be sorted and recycled in a waste recycling centre in accordance with the legislation in force in the country of installation. This will help reduce the impact on the environment, health and safety, and also promote recycling. Pentair does not collect used products for recycling. Contact your local recycling centre. for more information.



# 11 Annexes

## Electric diagrams of the E-Box INTELLIPOOL

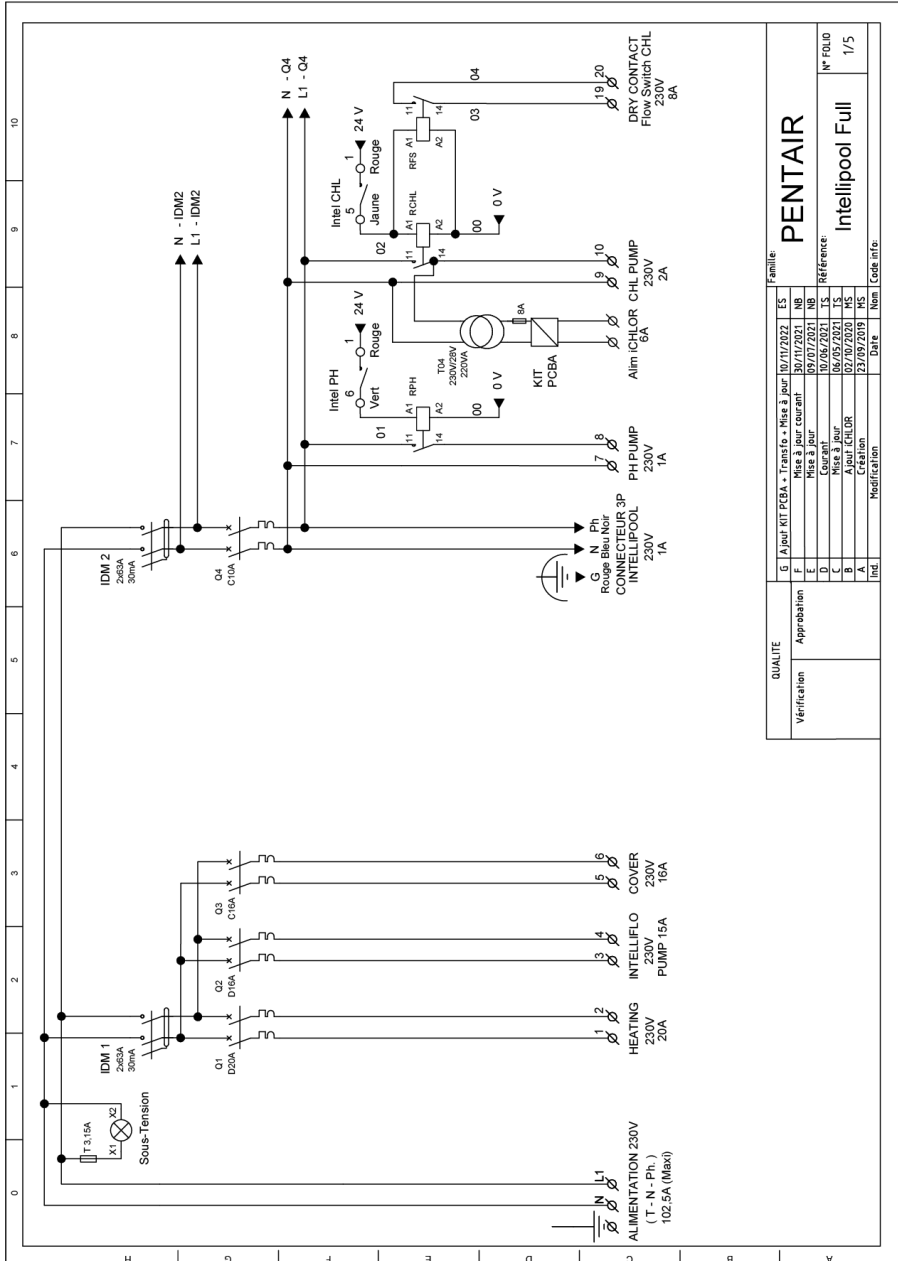

QUALITE		Famille			
Verification	G	Ajour KIT PCBA = Transfo + Mise à jour	10/11/2022	ES	<b>PENTAIR</b>  Intellipool Full N° FOLIO 1/5
Approbation	F	Mise à jour courant	30/11/2021	NB	
	E	Contrôle	05/07/2021	NB	
	D	Projet	10/06/2021	LS	
	C	Appr. CHL OR	02/10/2020	MS	
	B	Appr. PH OR	23/09/2019	MS	
	A	Création		MS	
	Inde.	Modification	Date	Norm	Code info.



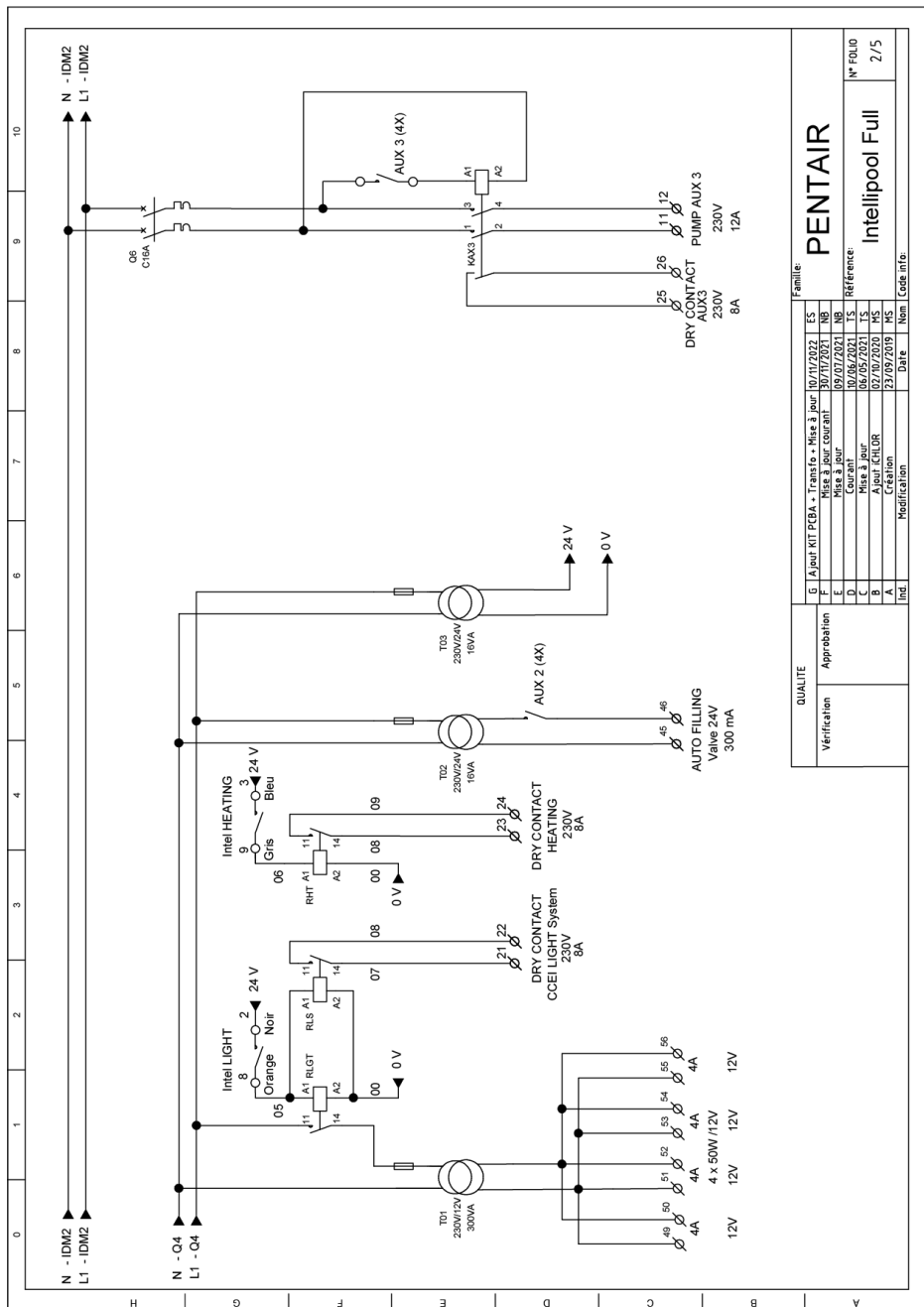

QUALITE		Famille	
G	Objet KIT PCBA - Transfo - Mise à jour	ES	10/11/2022
F	Approbation	NB	30/11/2021
E	Vérification	MB	09/07/2021
D		TS	30/06/2021
C		MS	02/07/2020
B		MS	02/07/2020
A		MS	23/09/2019
Ind.		MS	Modification

<b>PENTAIR</b>	
<b>Intellipool Full</b>	
Reference:	N° FOLD
	2/5

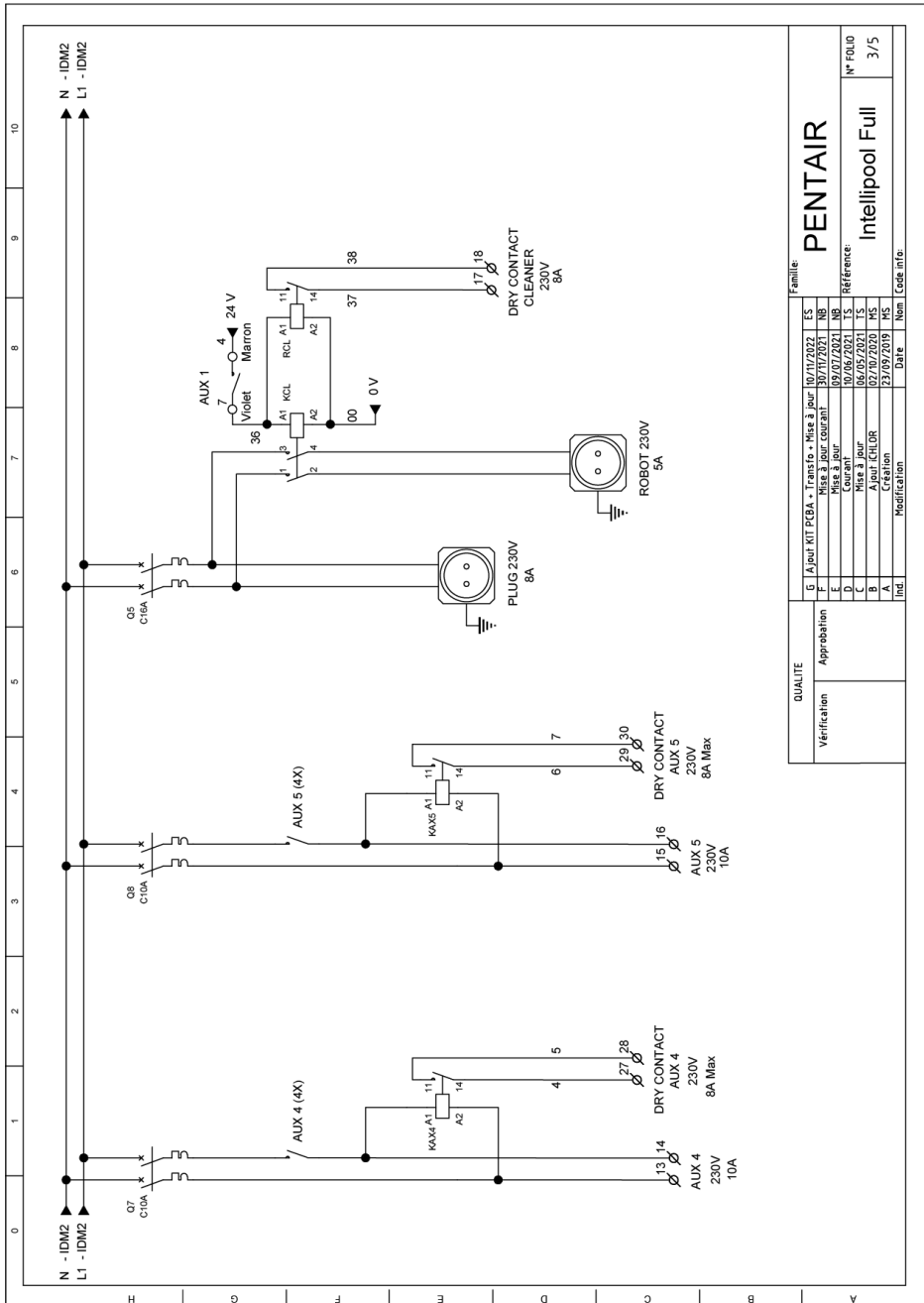

QUALITE		Famille:	
Vérification	Approbation	G	Ajust KIT E.C.B.A. - Transfo - Mise à jour ES
		F	Mise à jour courant 30/11/2021 NB
C	D	E	Mise à jour 06/05/2021 TS
		D	Mise à jour 10/06/2021 TS
B	A	C	Mise à jour 06/05/2021 TS
		B	Ajust CHLOR 02/10/2020 MS
Modifications		A	Création 23/09/2019 MS
IND		Date Nom Code info	

**PENTAIR**  
Intellipool Full

N° F01.0  
3/5

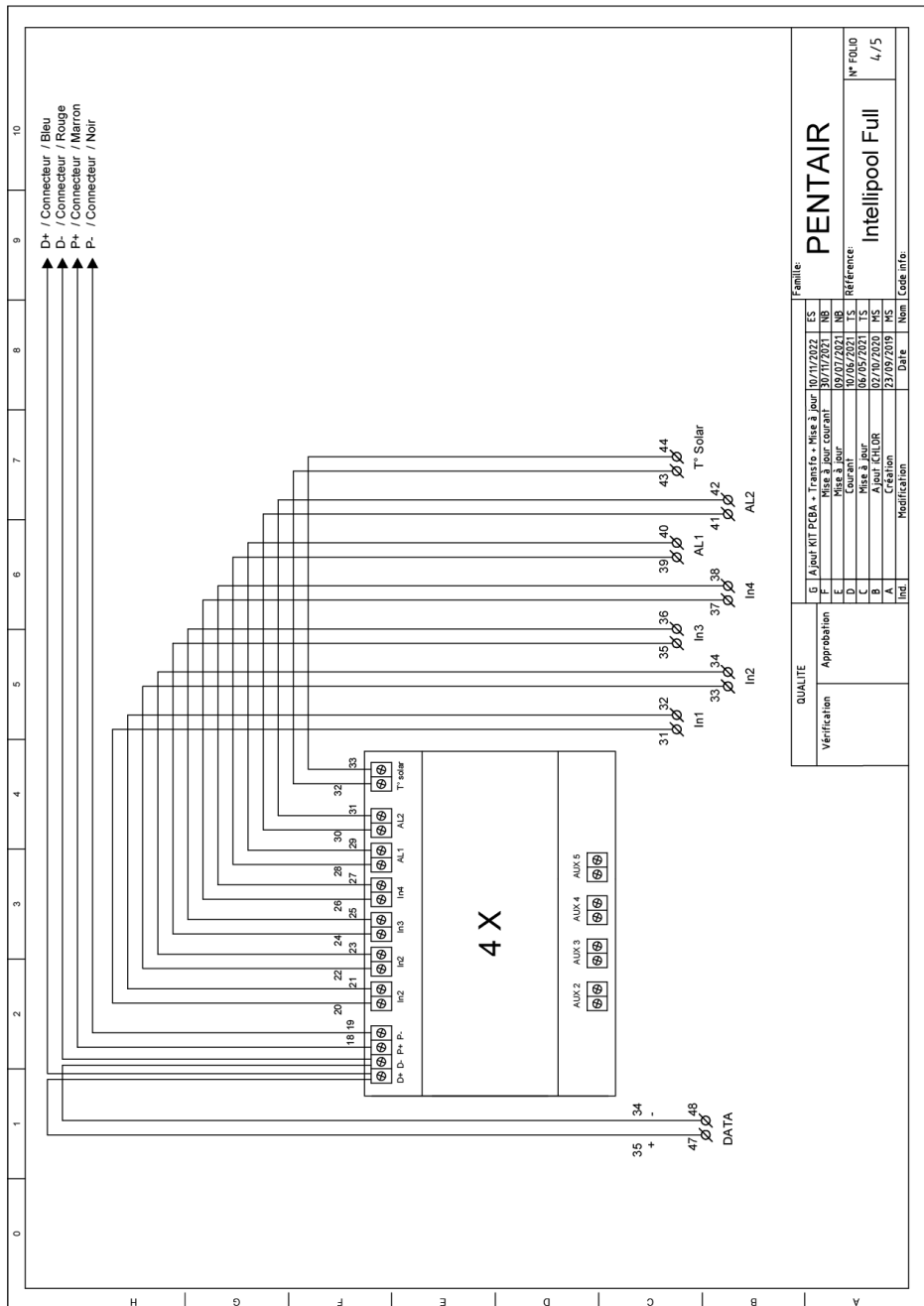

QUALITE		Famille	
Vérification	Approbation	G : Sujet KIT PCBA - Transfo - Mise à jour	ES
		F : Mise à jour courant	30/11/2022
		E : Mise à jour	30/11/2021
		D : Courant	09/07/2021
		C : Mise à jour	02/06/2021
		B : Ajout ECUOR	02/02/2021
		A : Création	23/09/2019
		Ind	Modif
		Ind	Code info
		PENTAIR	
		IntelliPool Full	
		N° FOLIO	
		4/5	

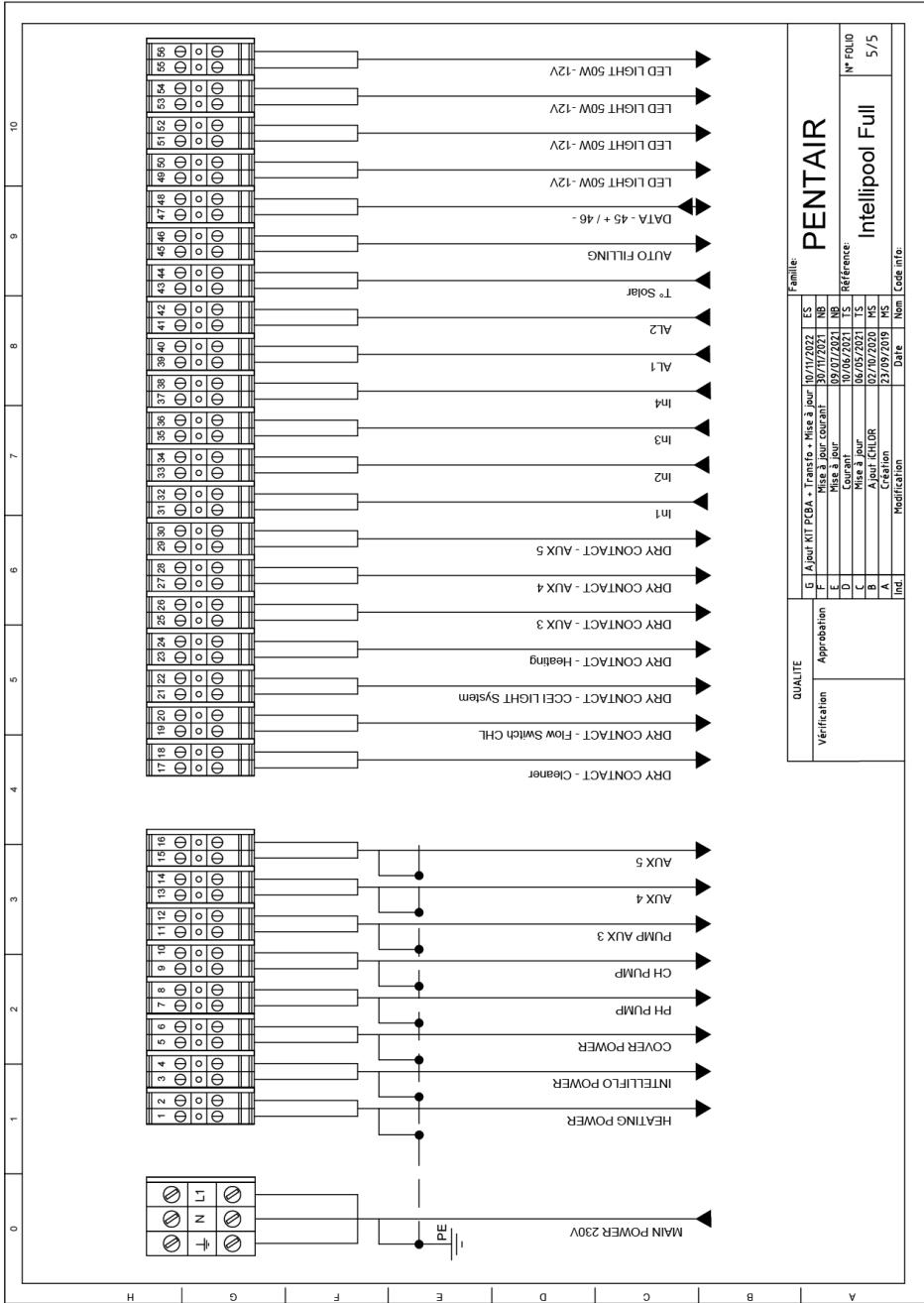

## Notes

**[WWW.PENTAIRPOOLEUROPE.COM](http://WWW.PENTAIRPOOLEUROPE.COM)**